

Energy Consumption Visualization Components

Data Logger Light

Make the power “visualization”
Promote eco-conscious operations



September 2010

New Release



Make Data Storage and Remote Monitoring

Data Logger Light (DLL) enables data collection/logging and data transfer via e-mail/websites, allowing you to establish networks of equipment, facilities, and services and streamline systems without requiring special knowledge.

Control of energy consumption in buildings/stores

Simply connecting the DLL to the target equipment allows data collection and logging to measure various characteristics, for example, energy consumption.

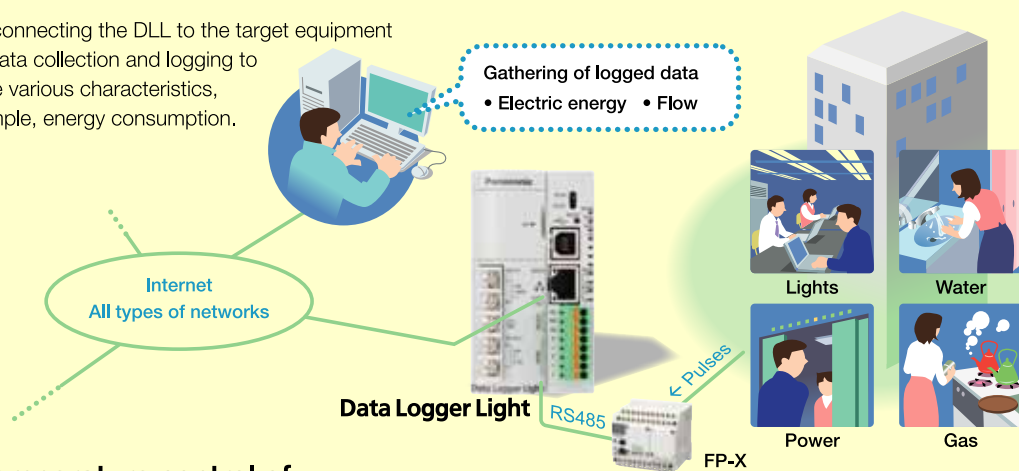

Temperature control of food-related equipment

HACCP-based remote temperature control of food-related equipment/facilities is possible.

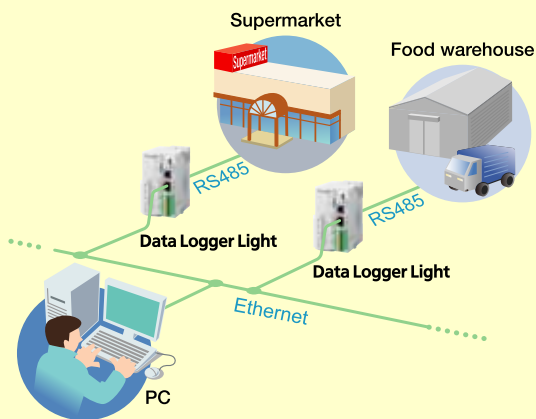

Facility and production streamlining

Operation data (log data of production quantity, errors, etc.) of each production line or floor of the factory can be remotely monitored and collected.

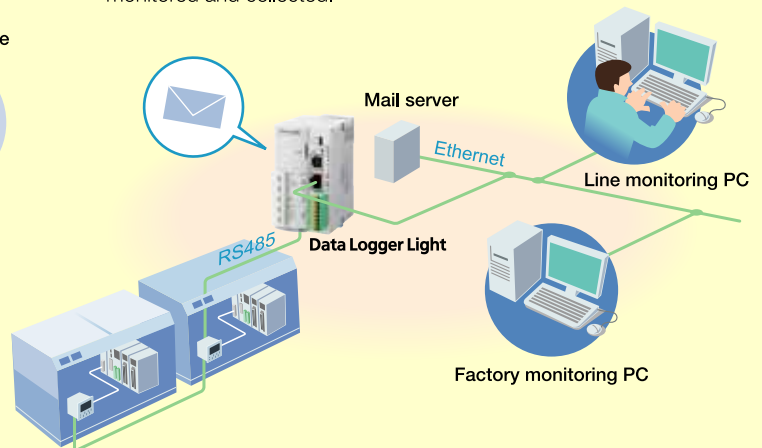

Data transfer without cables

Data can be exchanged between KW1M-H Eco-POWER METER and a PC and between DLL and a PC by using an SD/SDHC card.

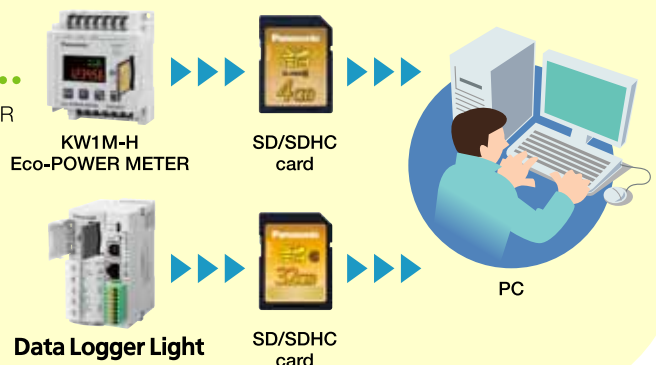

Easier for Everyone



Data Logger Light

● Dedicated software and USB connection facilitate on-site setup of DLL.

Dedicated software for setup without the DLL main unit

Even if the DLL main unit is remotely located, it is possible to complete the setup of registered devices and conditions on a PC.

Top menu screen



Click the "Easy Setup" icon, and you only need to follow the step-by-step guidance to complete the setting.

Station number setting screen



Simply tick the boxes in the "Station number setting screen" to choose measuring instruments connected via RS485.

Current value monitoring screen



Shows you the current setting status and data logging status. Ideal for monitoring from an office remote from the site.

*The screen images are only samples.

Equipped with both USB and LAN ports, to change settings

Setting data created on a PC can be transferred via the USB port. If the DLL is connected to a LAN, the data can also be transferred via the LAN port. Therefore, settings can be changed efficiently and smoothly either in standalone mode or as a component of a system.

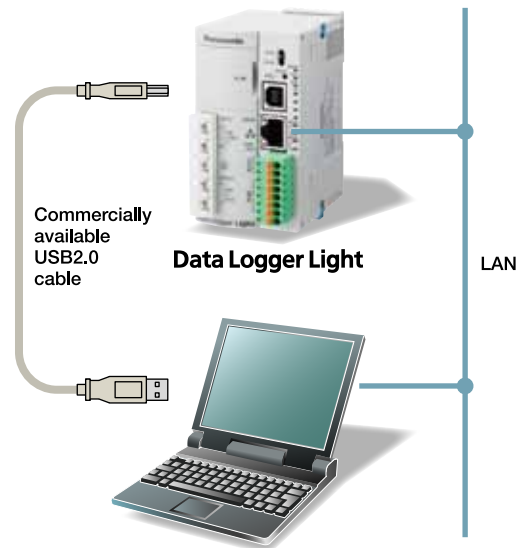

● Easy-to-install and set up all-in-one unit

Featuring the USB port, SD/SDHC card slot, and universal AC power supply, DLL can be easily installed with a reduction in required wiring, enhancing the convenience and cost effectiveness.

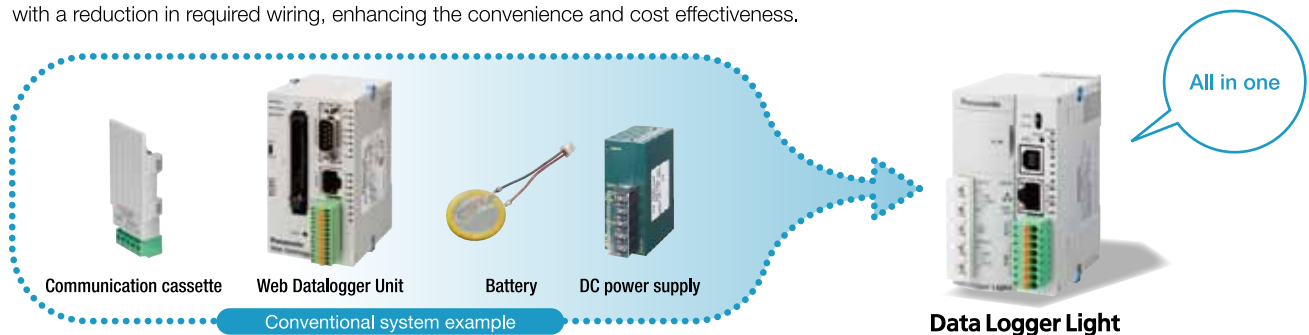

● Compatible with SD/SDHC cards

DLL is equipped with a slot for SD/SDHC cards, which are today's mainstream media. The slot features Class 10 high speed processing and is compatible with cards of up to 32 GB.

● Universal AC power supply and a built-in serial communication interface

Equipped with a built-in RS232C/RS485 interface. The power supply is compatible with 100 to 240 V AC. Also equipped with a 24 V DC, 0.2 A external service power supply for connection with other equipment.

Data Logger Light

Dimensions

(Unit: mm (inch))
(Tolerance: ±1.0 ±.039)

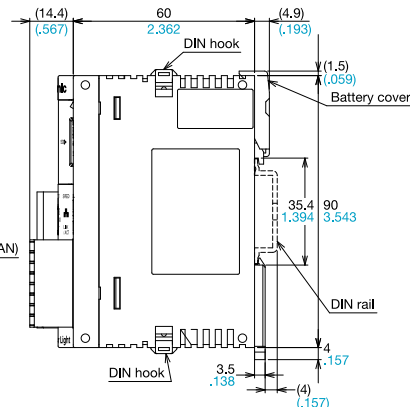
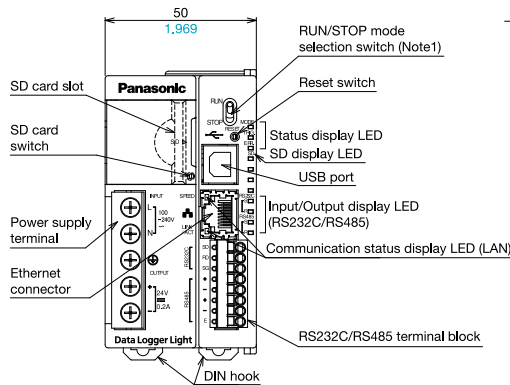
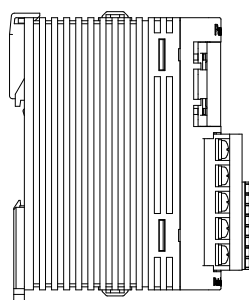

Terminal block wiring

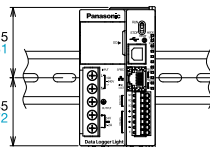
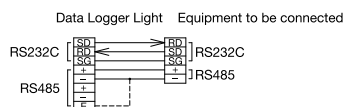

*For a terminal station unit, connect the negative terminal (-) to the ground terminal (E). It is sufficient to connect only one of the two negative terminals shown above.

Note 1: The factory default for the RUN/STOP mode selection switch is STOP mode.

Dimensions when mounted (1:2)

Specifications

Main unit

Rated operating voltage	100 to 240V AC
Allowable operating voltage range	85 to 264V AC (85 to 110 % of rated operating voltage)
Rated frequency	50/60Hz
Allowable momentary power-off time	Max. 10 ms
Rated output voltage	24V DC
Output voltage range	21.6V to 26.4V DC
Rated output current	0.2A*
Ambient temperature	-10 to +55°C +14 to +131°F
Storage temperature	-25 to +70°C -13 to +158°F
Current consumption	Max. 230 mA (at 100V AC)
Weight	Approx. 200 g (without battery)

*If a current load over the specified level is continuously applied, the unit may break down. When a short circuit is detected, the whole power supply of Data Logger Light will be shut down.

Performance specifications

Data accumulation	Logged data	Descriptions	Instantaneous, difference, average, minimum, and maximum values
		Data saving	Data format (Valid for the register system)
Data accumulation	Trigger	Number of registrable files	16
		Number of registrable devices*1	300 points/1 file
		Saved to*2	• Internal memory (SRAM): 1 MB • SD/SDHC cards: 2 to 32 GB
		File system	VFAT/FAT/FAT32
Data accumulation	Trigger	Saving format	CSV file type
		Number of storable files	100
Data accumulation	Trigger	Trigger type	• Constant cycle (user-selectable from 1 second to 24 hours) • Contact status (rising edge, falling edge, both edges, accumulation ON time, number of accumulation open/close operations, ON status, and OFF status) • Specified time (every minute, every hour, every day, every week, every month, every year, and specified time) • Register (=, >, <, ≠) • Trigger combinations (AND, OR)
		Number of registrable	128
Data accumulation	E-mail sending function	Transmission network	LAN
		E-mail content	Title: Within 16 one-byte or 8 two-byte characters Body: Within 256 one-byte or 128 two-byte characters
Data accumulation	Network function	Number of registrable	64 (with no files attached)
		Communication protocol	TCP/IP, UDP/IP
Data accumulation	Network function	Application protocol	SMTP (Capable of POP/APOP authentication), FTP (client/server), SNMP, DHCP, DNS

*1: The maximum total number of points for registrable devices is always 300, for either 1 file or 16 files.

*2: The internal memory can store data using the backup battery.

Please note that data stored in the internal memory may be lost when the battery has been depleted.

Product types

Product name	Descriptions	Model number
Data Logger Light (DLL)	Number of registrable devices: 300 points max. (Total of 300 points max. for either 1 or 16 files). Internal memory: 1 MB, SD/SDHC card: Max. 32 GB	AKL1000
Slim 30 type Mounting plate	Plate for perpendicularly installing the Data Logger Light (set for 10)	AFP0811
Flat type Mounting plate	Plate for installing Data Logger Light flush with the panel (set for 10)	AFP0804
Battery for FPΣ	For internal memory backup function and clock function	AFP804
Terminal screw driver	Using when wiring Phoenix terminal	AFP0806
Configurator DL	Data Logger Light setting software	
Configurator WD	IP addresses search tool (Ver.1.50 or more)	
Data Logger Light User's manual (pdf)	Manual describing how to use Data Logger Light and setting procedures	

You can download from our website (free of charge).
Customer registration is required to download data.

Communication specifications

Interface: Ethernet

Interface	IEEE802.3U, 10BASE-T/100BASE-TX	
Connector type	RJ45	
Transmission specifications	Transmission speed	10Mbps/100Mbps
	Transmission method	Base band
	Max. segment length	100 m
Communication cable	UTP (category 5)	
Functions	Auto-negotiation function, MDI/MDI-X auto-crossover function	

* Ethernet is a registered trademark of Xerox Corporation.

Interface: RS232C and RS485

Interface	RS232C (Not isolated from the internal circuit)	RS485 (Isolated from the internal circuit)
Communication form	1:1 communication	1:N communication
Number of connected units	1 unit	99 units*1 *2
Communication method	Half-duplex	
Synchronous system	Synchronous communication method	
Transmission distance	15 m	Max. 1200m*3
Transmission speed	4,800/9,600/19,200/38,400/57,600/115,200 bps	
Transmission format	Stop bit	1 bit/2 bit
	Parity	Odd number/Even number/Not available
	Data length	7bit/8bit
Protocol	MEWTCCOL	

*1: When using a PC as a slave station, you are recommended to use SI-35 or SI-35USB of LINEEYE Co., Ltd. as an RS485 interface.

*2: When using SI-35, SI-35USB, our Eco-POWER METER or our PLC (which can be connected up to 99 units), up to 99 units can be connected. In case using this system with the other devices, up to 31 units can be connected.

*3: The transmission distance is limited by the transmission speed and the number of units connected. When the speed is 38,400 bps or lower, the maximum transmission distance is 1,200 m, and the number of units is 99.

External memory specifications

SD card slot The use of a Panasonic SD card is recommended.

Support media	SD card
Supported format standards*1	Compliant with SD and SDHC standards
Memory capacity	2 to 32 GB
Speed class	Class2 to Class10

*1: To format SD cards, please download and use the formatting software available on the Panasonic website. [Panasonic website → Customer support → SD/SDHC card page → Software download list] http://panasonic.jp/support/sd_w/download
The file system on a SD card that was formatted using standard PC software does not comply with the SD card standard.

Panasonic Electric Works Co., Ltd.

Automation Controls Business Unit

■ Head Office: 1048, Kadoma, Kadoma-shi, Osaka 571-8686, Japan

■ Telephone: +81-6-6908-1050 ■ Facsimile: +81-6-6908-5781

panasonic-electric-works.net/ac

All Rights Reserved © 2010 COPYRIGHT Panasonic Electric Works

Specifications are subject to change without notice.

AACT1B67E 201009-3YT Printed in Japan.