

PRELIMINARY SPEC

Part Number: AA3529SYS/L

Super Bright Yellow

### Features

- Single color.
- Suitable for all SMT assembly and solder process.
- Available on tape and reel.
- Ideal for backlighting.
- White SMD package, silicone resin.
- Low thermal resistance.
- Package: 1500pcs / reel.
- Moisture sensitivity level : level 2a.
- RoHS compliant.

### Description

The source color devices are made with AlInGaP Light Emitting Diode.

### Package Dimensions

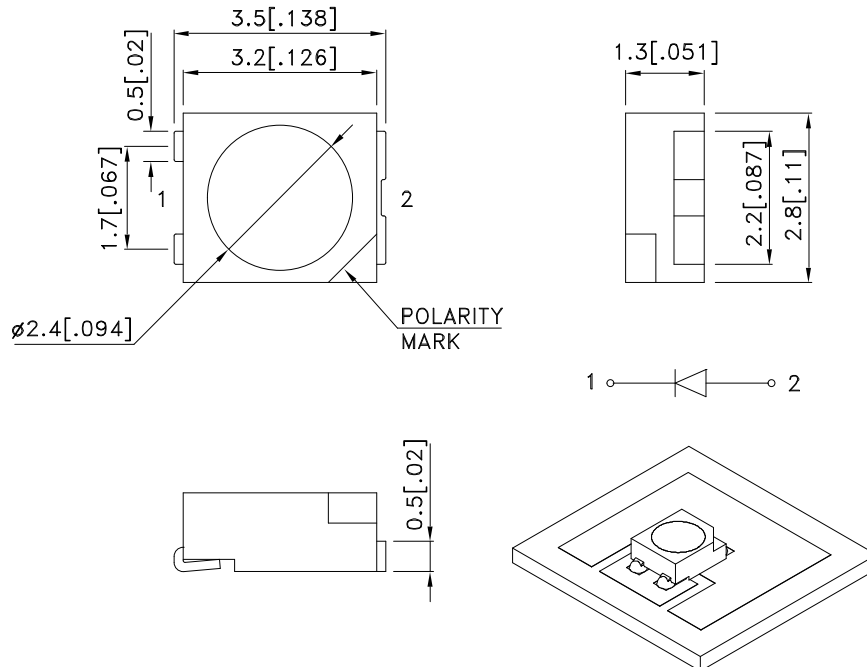

#### Notes:

1. All dimensions are in millimeters (inches).
2. Tolerance is  $\pm 0.25(0.01)$ " unless otherwise noted.
3. Specifications are subject to change without notice.
4. The device has a single mounting surface. The device must be mounted according to the specifications.



## Handling Precautions

Compare to epoxy encapsulant that is hard and brittle, silicone is softer and flexible. Although its characteristic significantly reduces thermal stress, it is more susceptible to damage by external mechanical force.

As a result, special handling precautions need to be observed during assembly using silicone encapsulated LED products. Failure to comply might leads to damage and premature failure of the LED.

1. Handle the component along the side surfaces by using forceps or appropriate tools.

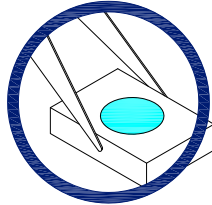

2. Do not directly touch or handle the silicone lens surface. It may damage the internal circuitry.

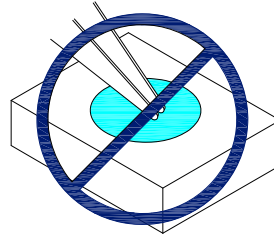
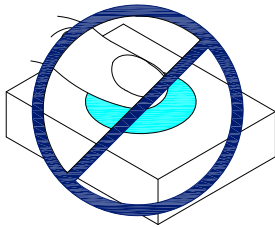

3. Do not stack together assembled PCBs containing exposed LEDs. Impact may scratch the silicone lens or damage the internal circuitry.

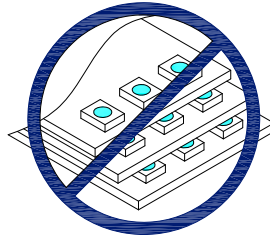

4. The outer diameter of the SMD pickup nozzle should not exceed the size of the LED to prevent air leaks. The inner diameter of the nozzle should be as large as possible.
5. A pliable material is suggested for the nozzle tip to avoid scratching or damaging the LED surface during pickup.
6. The dimensions of the component must be accurately programmed in the pick-and-place machine to insure precise pickup and avoid damage during production.

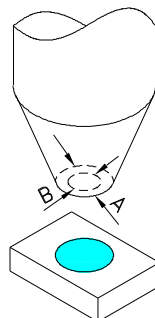

## Selection Guide

Part No.	Dice	Lens Type	Iv (mcd) [2] @ 150mA		Φv (mlm) [2] @ 150mA		Viewing Angle [1]
			Min.	Typ.	Min.	Typ.	2θ1/2
AA3529SYS/L	Super Bright Yellow (AlInGaP)	WATER CLEAR	1600	3000	3000	6000	120°

Notes:

1. θ1/2 is the angle from optical centerline where the luminous intensity is 1/2 the optical centerline value.
2. Luminous intensity / luminous flux: +/-15%.

## Electrical / Optical Characteristics at TA=25°C

Parameter	Symbol	Value	Unit
Power Dissipation	Pt	615	mW
Junction Temperature [1]	TJ	110	°C
Operating Temperature	Top	-40 To +85	°C
Storage Temperature	Tstg	-40 To +85	°C
DC Forward Current [1]	IF	150	mA
Peak Forward Current [2]	IFM	200	mA
Thermal Resistance [1] (Junction/ambient)	Rth j-a	210	°C/W
Thermal Resistance [1] (Junction/solder point)	Rth j-s	90	°C/W

Notes:

1. Results from mounting on PC board FR4 (pad size ≥ 70mm<sup>2</sup>), mounted on pc board-metal core PCB is recommend for lowest thermal Resistance.
2. 1/10 Duty Cycle, 0.1ms Pulse Width.

## Electrical / Optical Characteristics at TA=25°C

Symbol	Parameter	Device	Typ.	Max.	Units	Test Conditions
λ <sub>peak</sub>	Peak Wavelength	Super Bright Yellow	590		nm	IF=150mA
λ <sub>D</sub> [1]	Dominant Wavelength	Super Bright Yellow	590		nm	IF=150mA
Δλ <sub>1/2</sub>	Spectral Line Half-width	Super Bright Yellow	20		nm	IF=150mA
C	Capacitance	Super Bright Yellow	20		pF	VF=0V;f=1MHz
VF [2]	Forward Voltage	Super Bright Yellow	3.6	4.1	V	IF=150mA
IR	Reverse Current	Super Bright Yellow		10	uA	VR = 5V

Notes:

1. Wavelength: +/-1nm.
2. Forward Voltage: +/-0.1V.

## Super Bright Yellow

## AA3529SYS/L

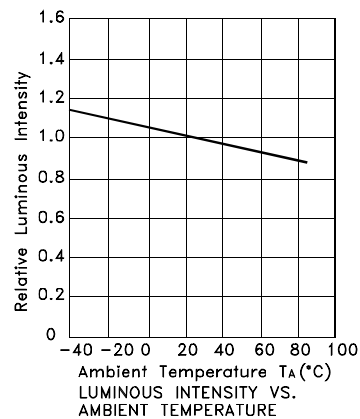
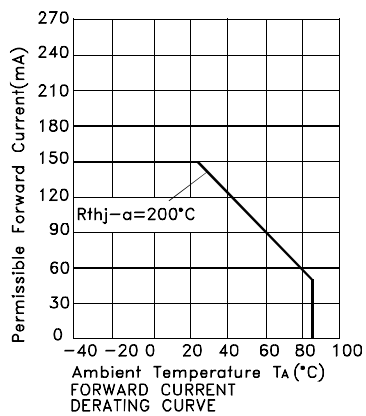
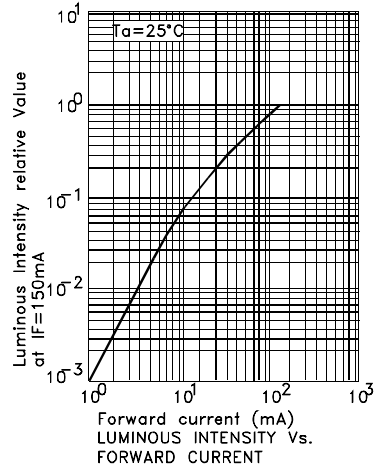
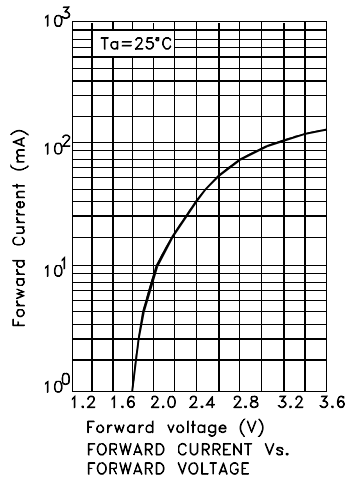
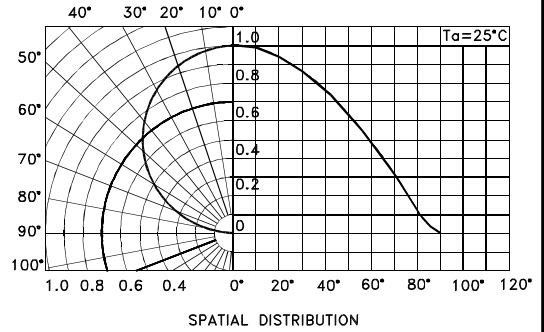
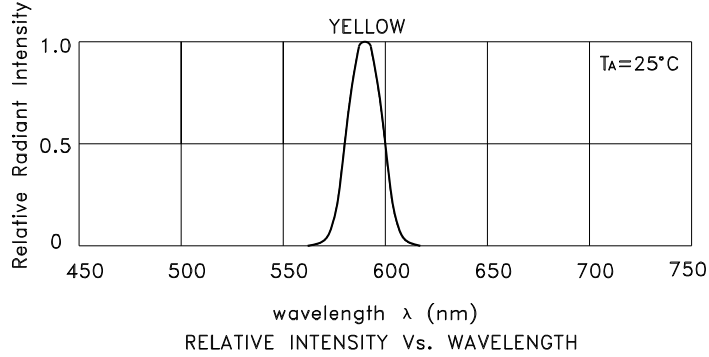

## AA3529SYS/L

Reflow soldering is recommended and the soldering profile is shown below.  
Other soldering methods are not recommended as they might cause damage to the product.

Reflow Soldering Profile For Lead-free SMT Process.

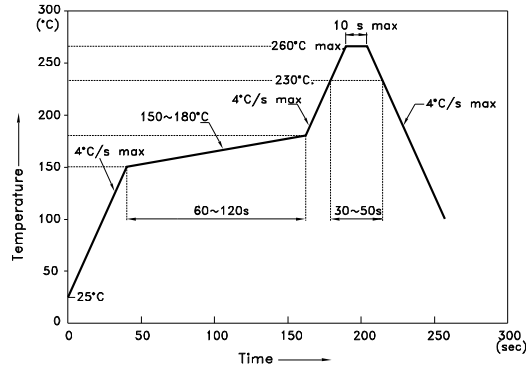

NOTES:

1. We recommend the reflow temperature 245°C (+/-5°C). The maximum soldering temperature should be limited to 260°C.
2. Don't cause stress to the epoxy resin while it is exposed to high temperature.
3. Number of reflow process shall be 2 times or less.

### Recommended Soldering Pattern (Units : mm; Tolerance: ± 0.1)

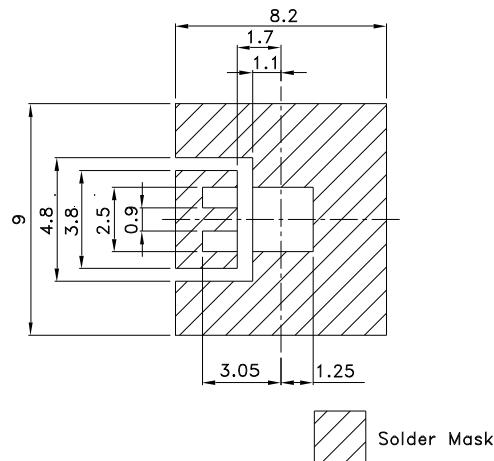

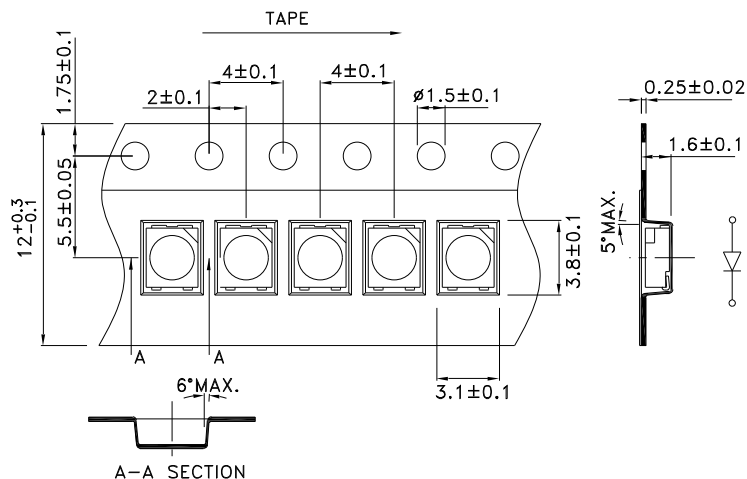

### Tape Specifications (Units : mm)

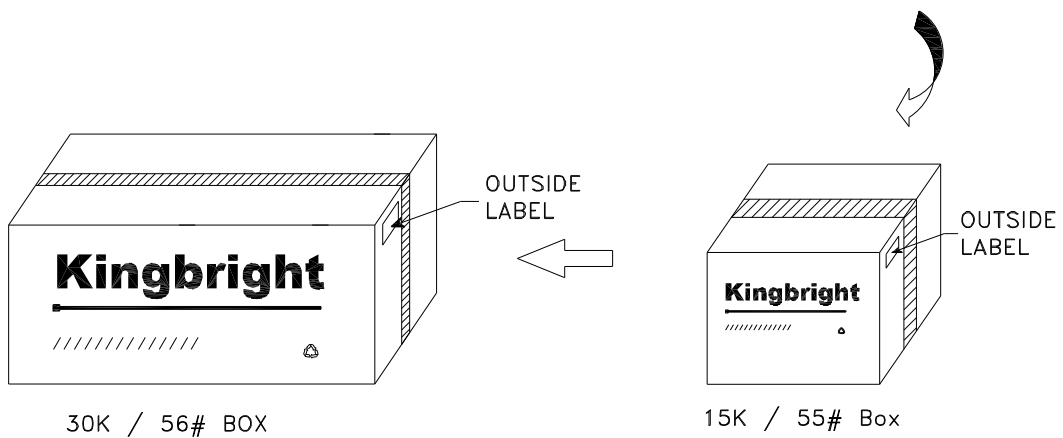
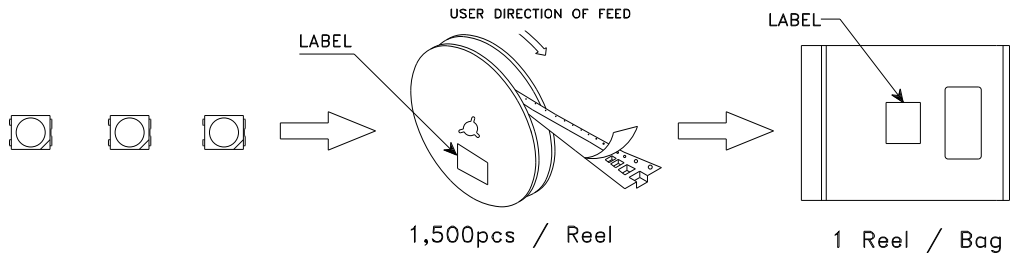

**PACKING & LABEL SPECIFICATIONS**

**AA3529SYS/L**



<h1>Kingbright</h1>	
P/NO: AA3529XXX	
QTY: 1,500 pcs	Q.C. <span style="border: 1px solid black; border-radius: 50%; padding: 2px;">Q C XX XX XXXX PASSED</span>
S/N: XXXX	
CODE: XXX	
LOT NO:	
 <small>XXXXXXXXXXXXXXXXXXXX</small>	
RoHS Compliant	