



Simplifying System Integration™

78M6612 AC-PMON Evaluation Board User Manual

**February 1, 2010
Rev. 1.1
UM_6612_013**

© 2010 Teridian Semiconductor Corporation. All rights reserved.
Teridian Semiconductor Corporation is a registered trademark of Teridian Semiconductor Corporation.
Simplifying System Integration is a trademark of Teridian Semiconductor Corporation.
Microsoft, Windows, Vista, and Excel are registered trademarks of Microsoft Corporation.
CA51 is a trademark of Keil, An ARM[®] Company.
Signum Systems is a trademark of Signum Systems Corp.
LabVIEW, NI and NI-VISA are trademarks of National Instruments.
All other trademarks are the property of their respective owners.

Teridian Semiconductor Corporation makes no warranty for the use of its products, other than expressly contained in the Company's warranty detailed in the Teridian Semiconductor Corporation standard Terms and Conditions. The company assumes no responsibility for any errors which may appear in this document, reserves the right to change devices or specifications detailed herein at any time without notice and does not make any commitment to update the information contained herein. Accordingly, the reader is cautioned to verify that this document is current by comparing it to the latest version on <http://www.teridian.com> or by checking with your sales representative.

Teridian Semiconductor Corp., 6440 Oak Canyon, Suite 100, Irvine, CA 92618
TEL (714) 508-8800, FAX (714) 508-8877, <http://www.teridian.com>

Table of Contents

1	Introduction	5
1.1	Package Contents	5
1.2	System Requirements.....	5
1.3	Safety and ESD Notes	6
1.4	Firmware Demo Code Introduction.....	6
1.5	Testing the AC-PMON Evaluation Board Prior to Shipping	6
2	Installation	7
2.1	USB Driver Installation	7
2.2	Confirm COM Port Mapping.....	8
2.3	Basic Connection Setup.....	9
2.4	Verify Serial Connection to the PC.....	11
2.5	NI RunTime Installation.....	13
2.6	Install LabWindows™ XP Pro Update	16
3	Operating the Dashboard GUI.....	19
3.1	Port Selection	19
3.2	Creating a Measurement Data Log File.....	20
3.3	Selecting the Power Display Parameter	20
3.4	Selecting the Display Scales	21
3.5	Resetting the Min and Max Indicators to Their Current Values.....	21
3.6	Begin Tracking Minimum and Maximum Conditions	22
3.7	Selecting Outlet1	22
3.8	Selecting Wide Band or Narrow Band Measurement	23
3.9	Selecting the Sample Interval.....	23
3.10	Alarm Status.....	23
3.11	Neutral Voltage Alarm.....	24
3.12	Line Frequency.....	24
3.13	Accumulated Energy Usage and Expense Tracking	25
3.14	Displaying Narrowband and Wideband Values Simultaneously	25
3.15	Using the Parameter Graph	26
3.16	Setting Alarm Status Thresholds.....	26
3.17	Relay Configuration Controls	27
3.18	Log File Import to Excel®	28
4	Schematics, Bill of Materials and PCB Layouts	31
4.1	78M6612 AC-PMON Evaluation Board Schematics.....	31
4.2	78M6612 AC-PMON Evaluation Board Bill of Materials	33
4.3	78M6612 AC-PMON Evaluation Board PCB Layouts	34
4.4	USB Daughter Board Schematics	35
4.5	USB Daughter Board Bill of Materials.....	35
5	Ordering Information.....	36
6	Included Documentation	36
7	Contact Information.....	36
	Revision History	36

Figures

Figure 1: AC-PMON Connections	9
Figure 2: AC-PMON Application Diagram	9
Figure 3: 78M6612 Evaluation Board Electrical Schematic (1 of 2).....	31
Figure 4: 78M6612 Evaluation Board Electrical Schematic (2 of 2).....	32
Figure 5: 78M6612 Evaluation Board PCB Top View	34
Figure 6: 78M6612 Evaluation Board PCB Top Copper.....	34
Figure 7: USB Daughter Board Electrical Schematic.....	35

Table

Table 1: COM Port Setup Parameters.....	11
Table 2: 78M6612 Evaluation Board Bill of Materials.....	33
Table 3: USB Daughter Board Bill of Materials.....	35

1 Introduction

The Teridian Semiconductor Corporation (TSC) 78M6612 AC-PMON Evaluation Board is an electrical measurement unit for performing measurements from a single electrical outlet. It incorporates the TSC 78M6612 single-phase, dual-outlet, power and energy measurement IC. The AC-PMON Evaluation Board is connected to PC through a USB cable such as one provided in the demo kit package. The Evaluation Board demonstrates the capability of the 78M6612 energy meter controller chip for measurement accuracy and overall system use.

The board is pre-programmed with demo firmware (file name 6612_OMU_S2_URT_V1_13.hex) in the flash memory of the 78M6612 IC that allows evaluation of the capability of the IC.

Included with the AC-PMON is a Windows® based Graphical User Interface (GUI) for simplified access to the following measurement data and controls:

- Power, current, voltage and power factor indicator dials
- Adjustable display scales
- Minimum and peak parameter tracking
- Selectable strip chart display format
- Narrow-band versus Wide-band measurement
- Selectable sample size averaging
- Accumulated energy usage and expense tracking
- Line frequency
- Alarm indicators
- Programmable Alarm thresholds
- Data log to file



Alternatively, the user can directly query the device with the command set using HyperTerminal and the provided *6612_OMU_S2_URT_V1_13 Firmware Description Document*.

1.1 Package Contents

The 78M6612 AC-PMON Evaluation Board Demo Kit includes:

- 78M6612 AC-PMON Evaluation Board
- USB Daughter Board
- USB Cable Assembly USB A-B 28/24 1.8M (Tyco/Amp 1487588-3)
- CD with OMU Software and Documentation

1.2 System Requirements

The 78M6612 AC-PMON Evaluation Board requires use of a PC with the following features:

- PC (1 GHz, 1 GB) with Microsoft® Windows XP or Win2000, equipped with USB port.
- Minimum 1024 x 768 video display resolution.

1.3 Safety and ESD Notes



EXERCISE CAUTION WHEN LIVE AC VOLTAGES ARE PRESENT!



Standard ESD precautions must be taken when handling electronic equipment. The AC-PMON contains ESD protected interfaces.

Do not connect test equipment, ICE emulators or external development boards directly to the OMU-RF hardware. Damage to the OMU1-S-RF and external equipment will occur due to the 78M6612's "high side" reference topology. The 78M6612's V3P3 (i.e. "high side") is connected directly to Neutral (Earth Ground) creating a ground reference disparity with any properly grounded external equipment.

1.4 Firmware Demo Code Introduction

The Firmware Demo Code provides the following features:

- Basic energy measurement data such as Watts, Volts, current, VAR, VA, phase angle, power factor, accumulated energy, frequency, date/time, and various alarm statuses.
- Control of alarm thresholds, calibration coefficients, temperature compensation, etc.

There are two means to facilitate performance evaluation between the user at the PC host and the firmware code in the board:

- The Graphical User Interface (GUI). This document describes the installation and use of the Windows based GUI.
- The Command Line Interface (CLI) via HyperTerminal or comparable terminal emulator on a different operating system. For information about the CLI, see the *6612_OMU_S2_URT_V1_13 Firmware Description Document*.

The AC-PMON is shipped with Demo Code Revision 1.13 or later loaded in the 78M6612 chip and included on the CD. The code revision can be verified by entering the command `>i` via the command line interface. Firmware for the Demo Unit can be updated using either the Teridian TFP1 or an in-circuit emulator such as the Signum Systems™ ADM-51 (<http://www.signum.com/Signum.htm>).

The board components and firmware settings are designed to operate with the following nominal AC electrical ranges:

Voltage	Current	Line Frequency
110-240 VAC	10 mA – 20A	46-64 Hz

1.5 Testing the AC-PMON Evaluation Board Prior to Shipping

Before every AC-PMON Evaluation Board is shipped, the following procedures have been performed at the factory:

- Full Calibration – Precise energy source equipment is used to calibrate the current and voltage. The temperature is also calibrated at the same time.
- Accuracy Test – This "bench" level test ensures the energy accuracy is within +/-0.5%.

2 Installation

2.1 USB Driver Installation

This evaluation kit includes an optically isolated USB adaptor board for serial communications with a PC. The FTDI USB controller IC FT232RL performs the USB functions. The FTDI Windows driver presents a virtual COM port for enabling serial communications. Control of the AC-PMON module can be managed using either a terminal emulation program or using the supplied Windows Dashboard GUI. The FTDI Windows driver is a certified driver for Windows 2000 and XP.

1. Upon attaching the AC-PMON to the PC, the Found New Hardware Wizard automatically launches and installs the appropriate driver files. If your PC does not find the FTDI driver files on its local hard disk drive, locate and reference the FTDI USB Driver and Utilities subdirectory on the CD. The FT232RL controller is powered from the USB cable and is active even when no AC power is applied to the AC-PMON.

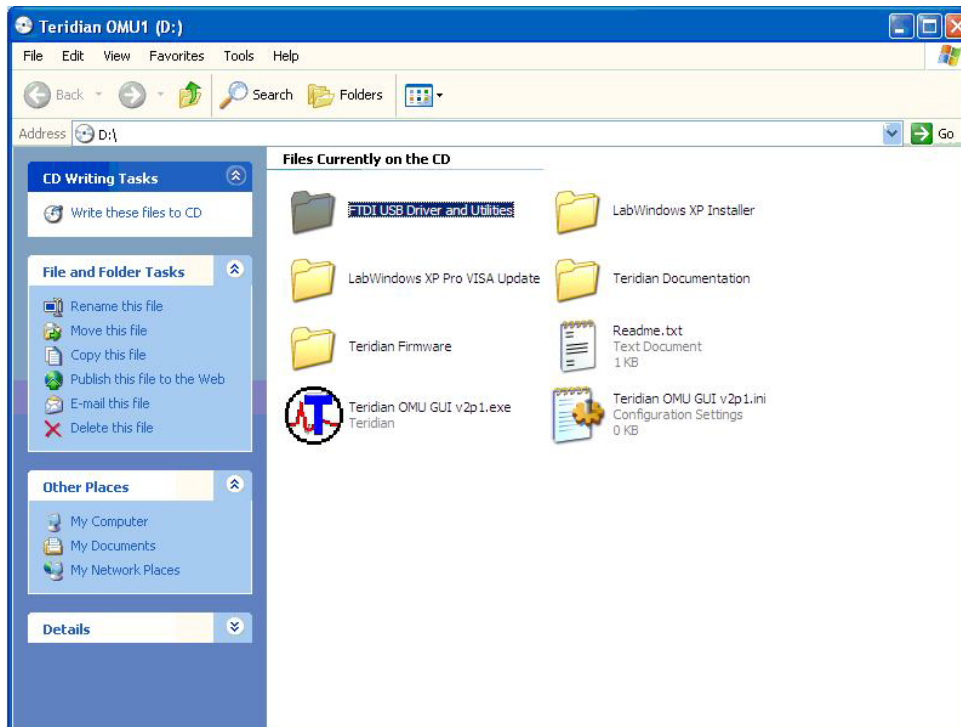

Notes: If an older FTDI driver has been previously installed, it is recommended to remove the older version before installing this newer FTDI driver. Execute the **fdiClean.exe** utility from the FTDI USB Driver and Utilities subdirectory.

For FTDI driver support on other operating systems, please check FTDI's website at (<http://www.ftdichip.com/FTDrivers.htm>).

2.2 Confirm COM Port Mapping

1. Launch the **Control Panel** and click on the **System** icon.

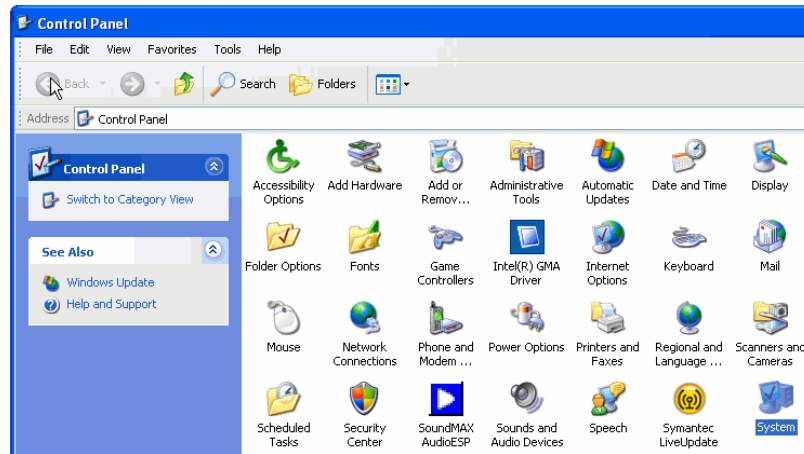

2. The **System Properties** screen appears. Click on the **Hardware** tab. Click on **Device Manager**. Under **Ports (COM & LPT)**, look for the **USB Serial Port** assignment.

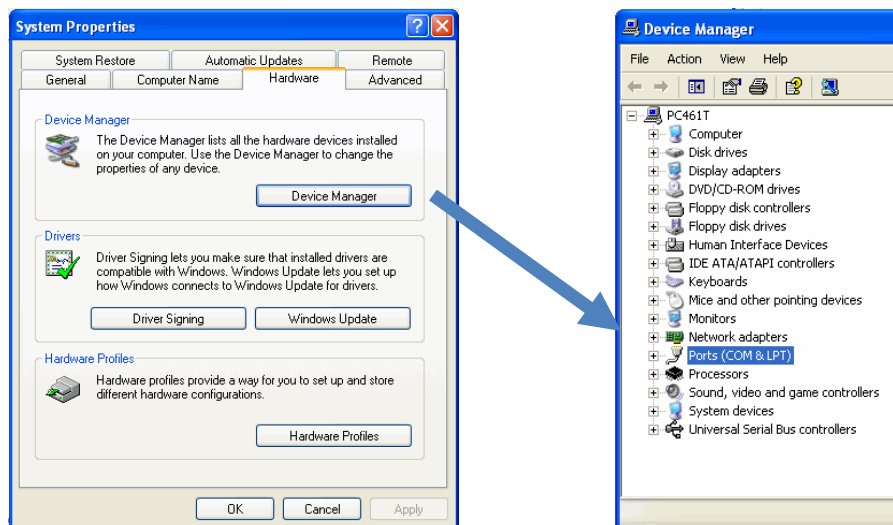

3. Take note of the COM port assignment for the USB Serial Port.

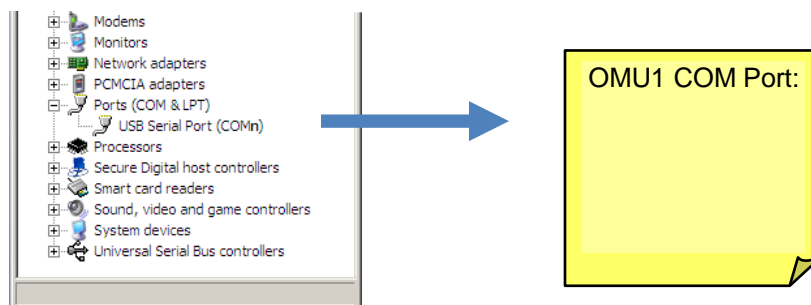

2.3 Basic Connection Setup

Figure 1 shows the basic connections of the 78M6612 AC-PMON Evaluation Board with the external equipment. The AC-PMON is powered through the USB cable. This same USB cable provides the communications link between the host PC and the AC-PMON.

The AC-PMON has two IEC 60320 connectors, one male and one female. The male connector is for inlet and the female connector is for outlet. The male connector is connected to a power chord from a wall outlet. The female connector connects to the load to be measured

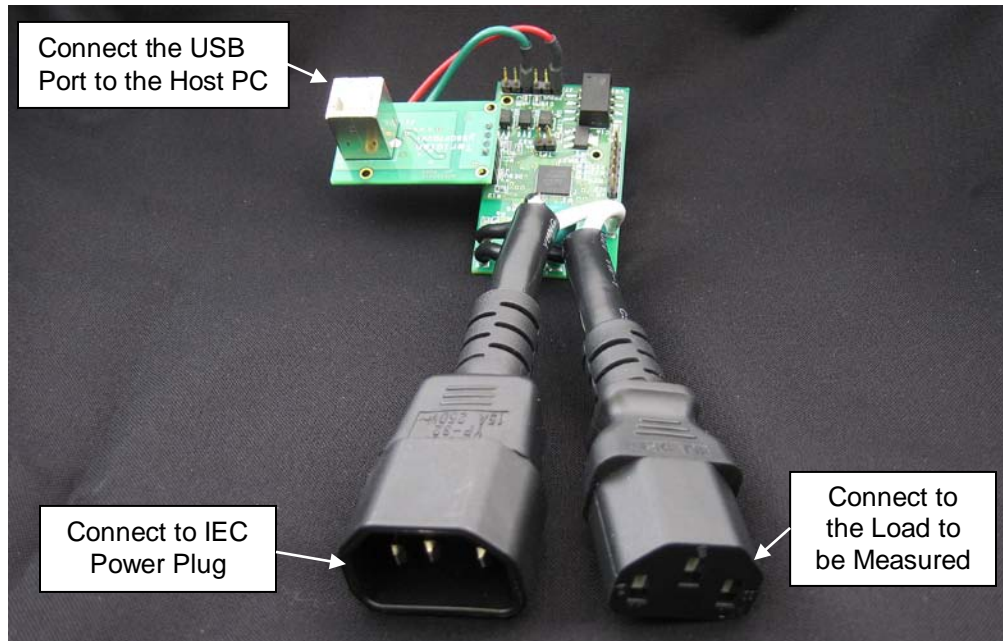

Figure 1: AC-PMON Connections

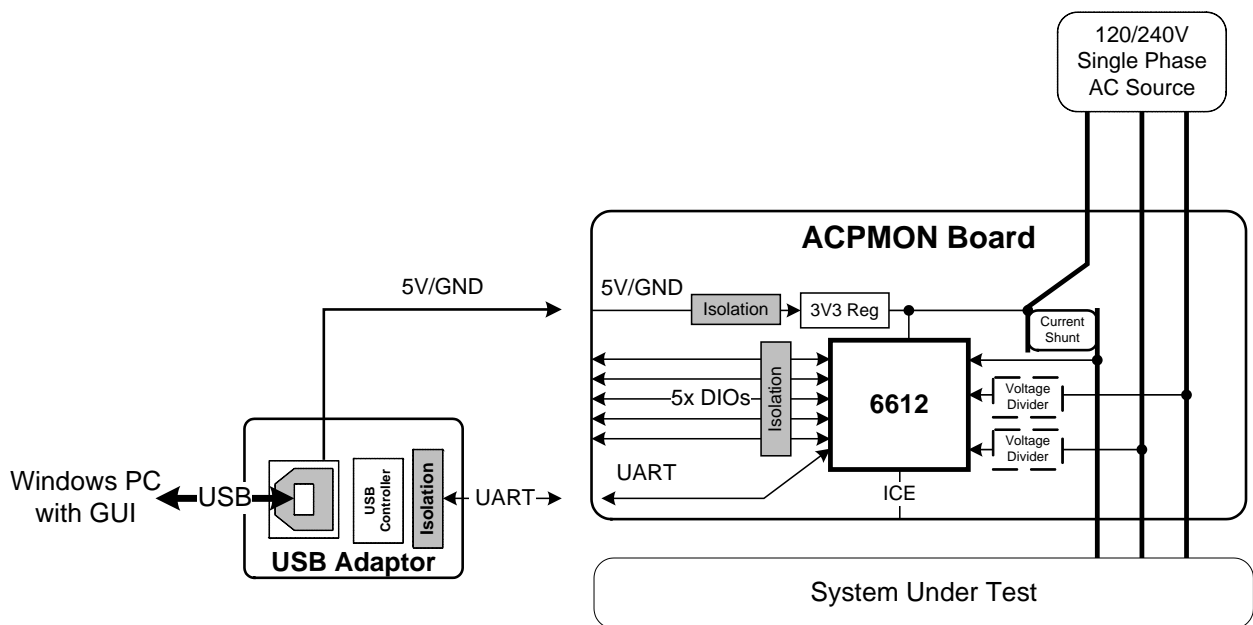
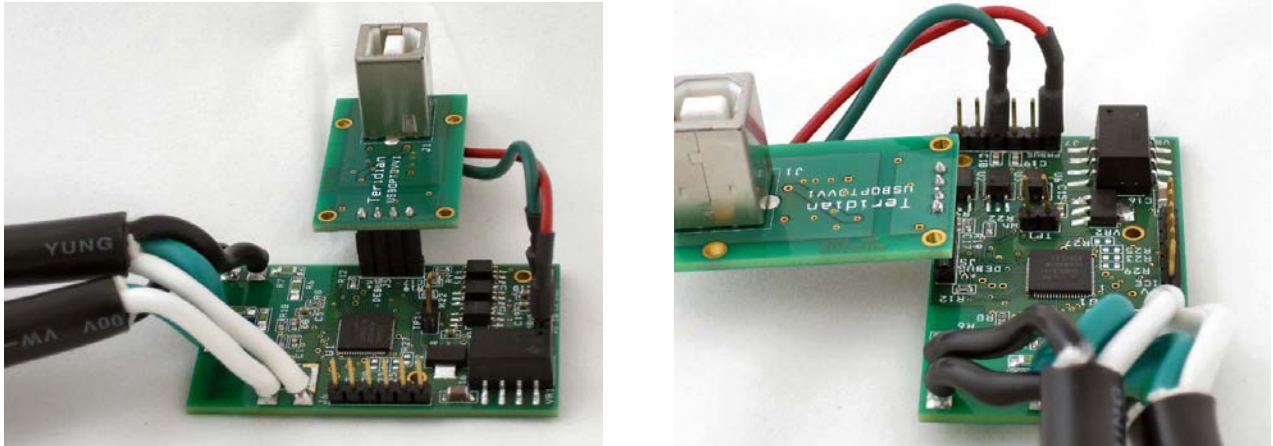

Figure 2: AC-PMON Application Diagram

The USB board connects to the AC-PMON Evaluation Board as shown below.



The red and green wires of the USB board connect to J7.1 and J7.4 of the AC-PMON Evaluation Board, respectively, and are the wires that carry the 5VDC and GND to the AC-PMON Evaluation Board.

2.4 Verify Serial Connection to the PC

After connecting the USB cable from the AC-PMON to the host PC, start the HyperTerminal application (or another suitable communication program) and create a session using the communication parameters show in Table 1.

Table 1: COM Port Setup Parameters

Setup Parameter	78M6612
Port speed (baud)	38400
Data bits	8
Parity	None
Stop bits	1
Flow control	Xon/Xoff

HyperTerminal can be found in Windows by selecting **Start → All Programs → Accessories → Communications → HyperTerminal**. The connection parameters are configured by selecting **File → Properties**. The **New Connection Properties** menu appears.

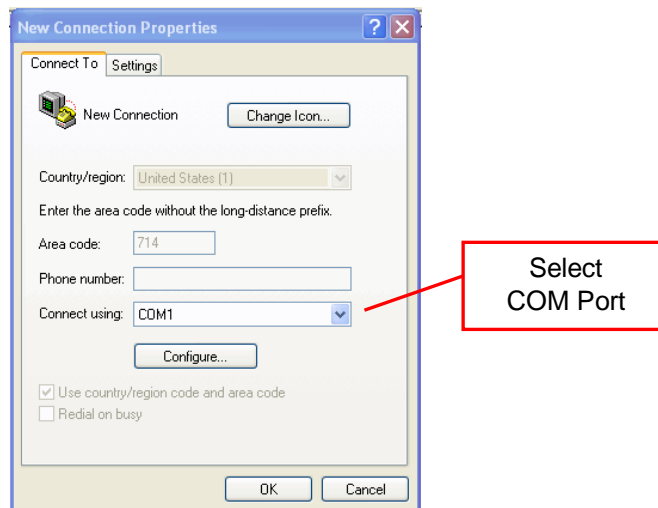

Select the appropriate COM port and click **Configure**. The **COMn Properties** menu appears.

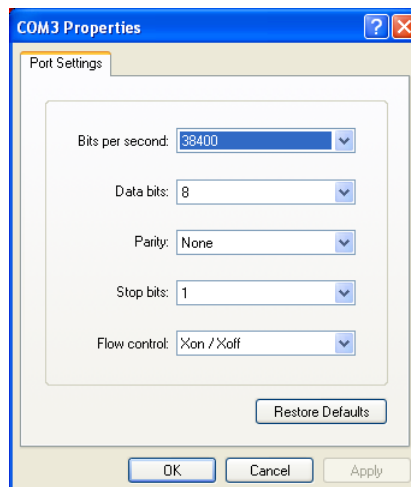

Note that port parameters can only be adjusted when the connection is not active. It may be necessary to click the Disconnect Button to disconnect the port.

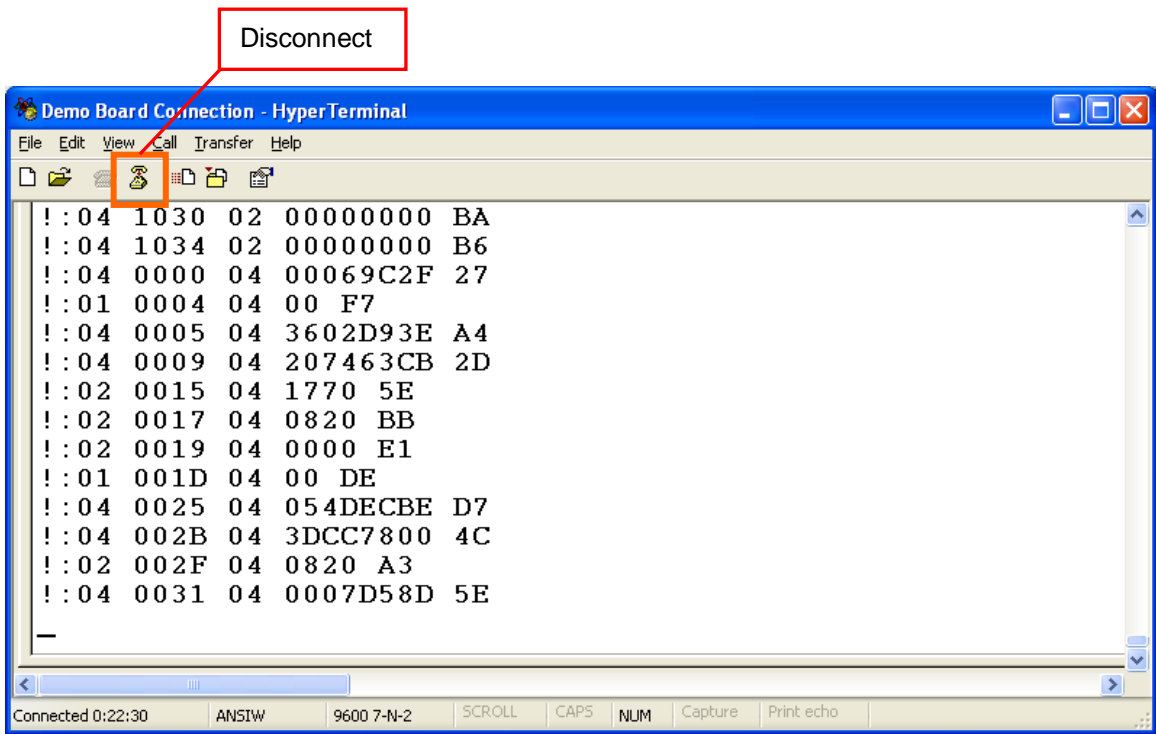

2.5 NI RunTime Installation

The GUI Dashboard program is created using National Instruments LabVIEW®. The NI RunTime Engine must be installed first before launching the Dashboard GUI.

1. Open the **LabWindows XP Installer** directory on the CD.

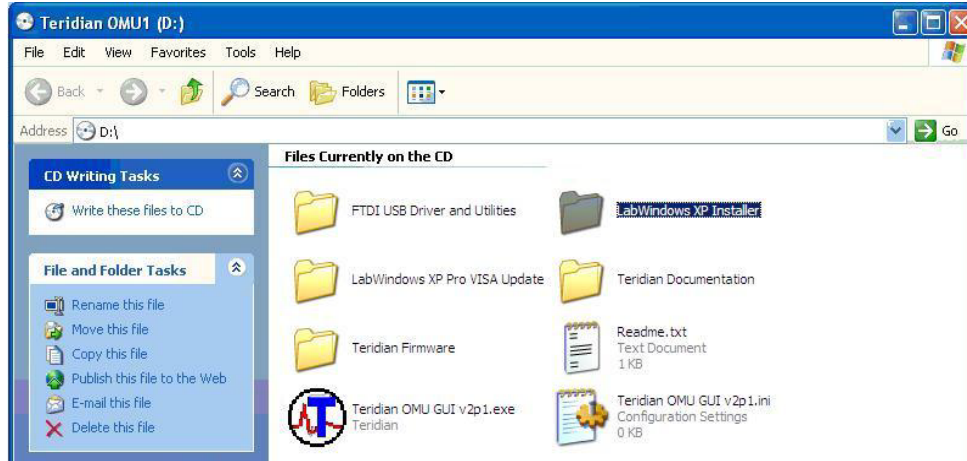

2. Execute the **setup.exe** file.

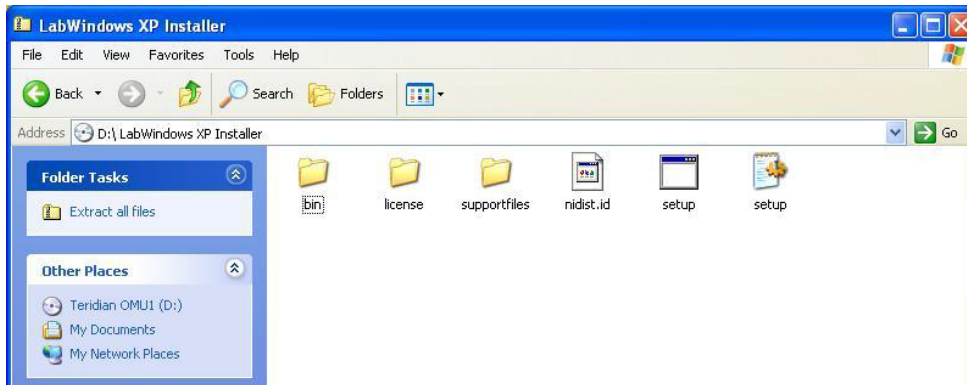

3. Select the destination directory.

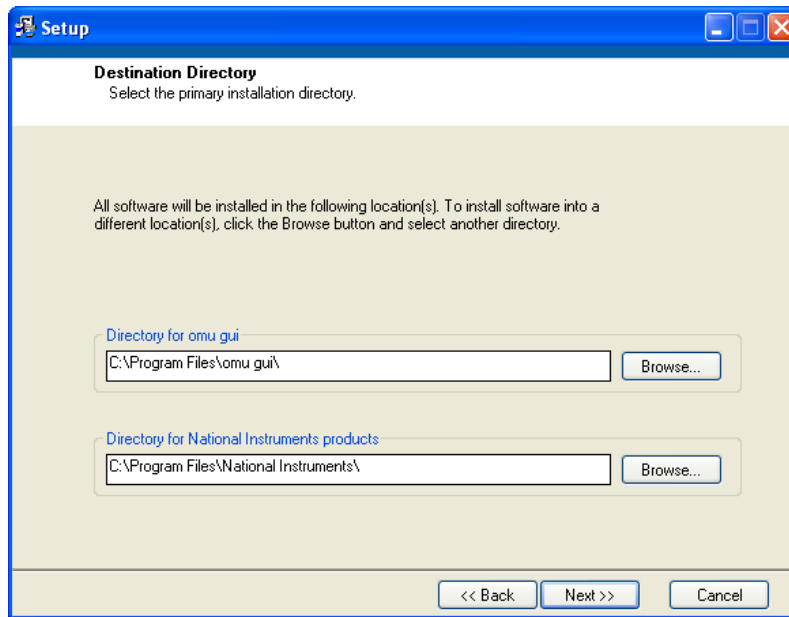

4. Accept the License Agreement.

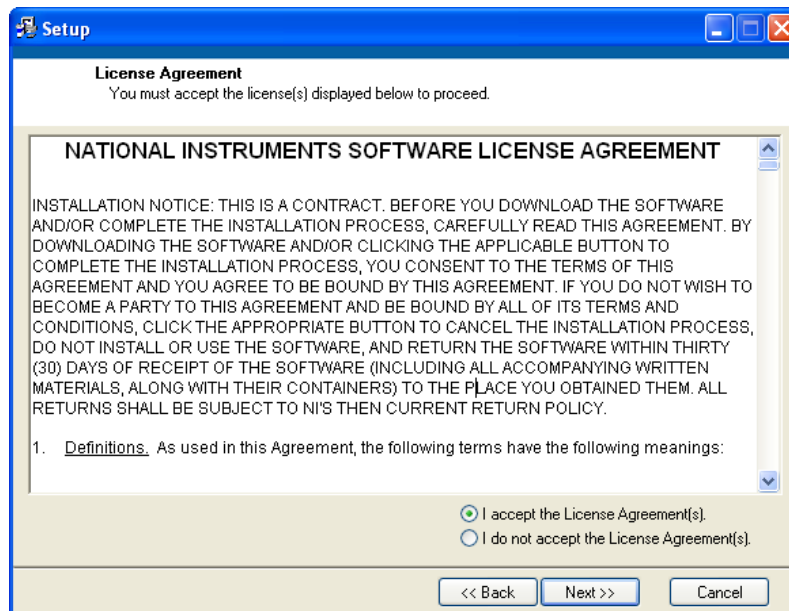

5. Start the installation.

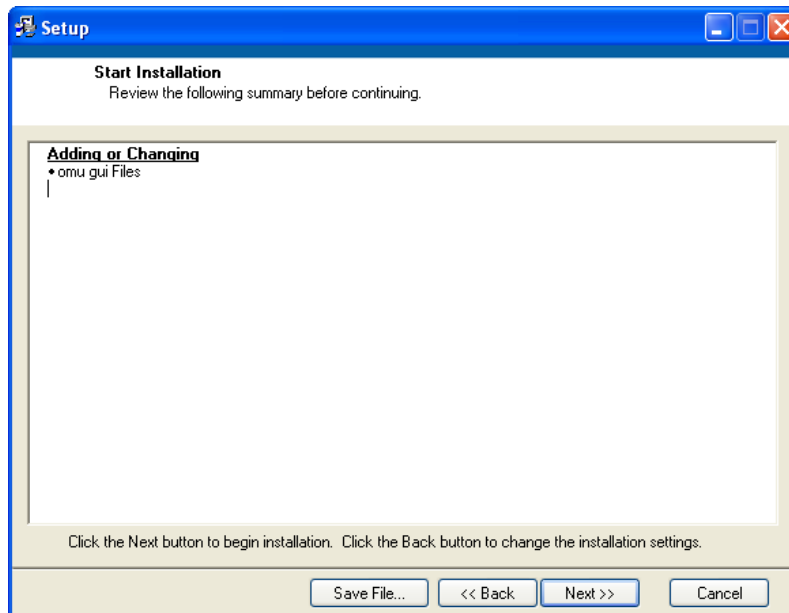

6. When the installation is complete, restart your computer.

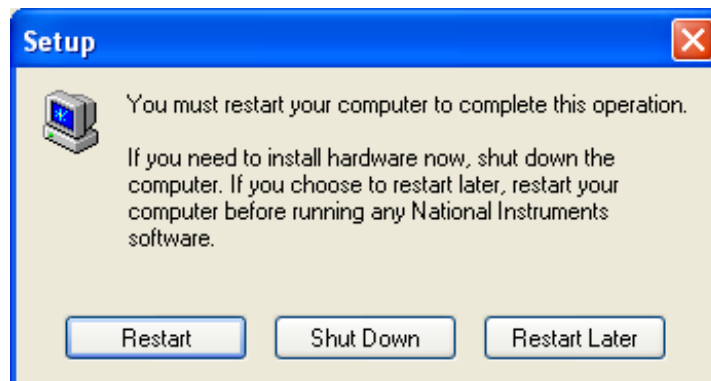

2.6 Install LabWindows™ XP Pro Update

Do not install LabWindows XP Pro Update on Win2k.

1. Launch the **LabWindows XP Pro VISA Update.exe** installation file on the CD.

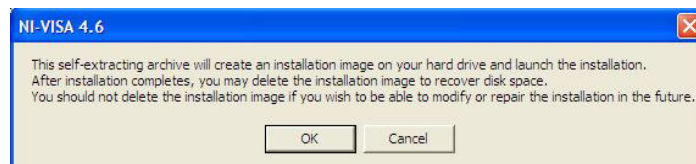
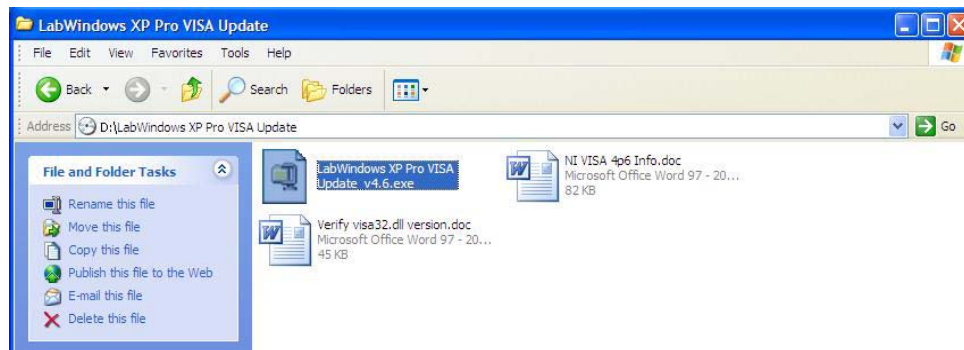
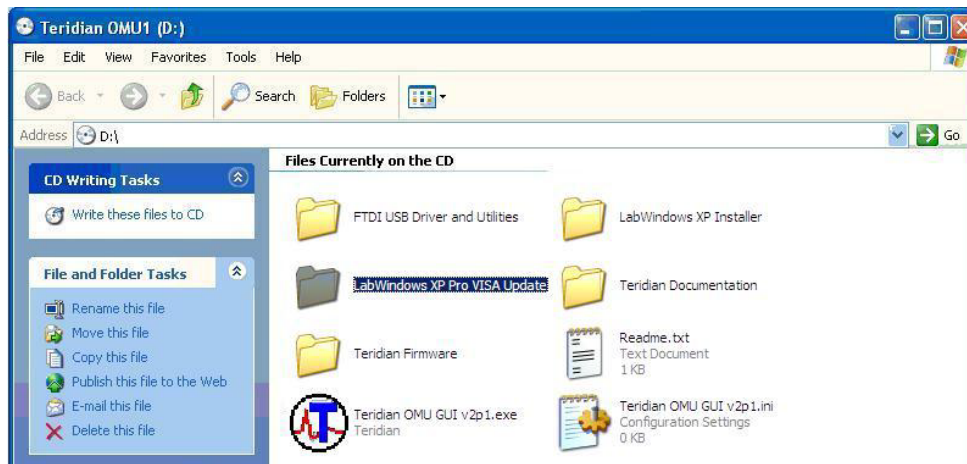

2. Un-zip the file to the proper folder.

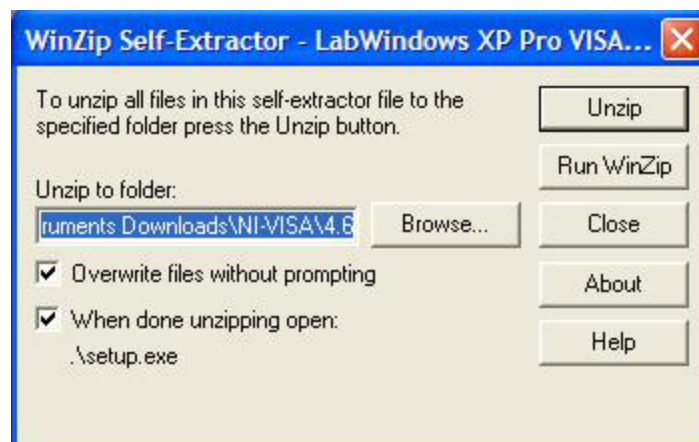

3. Start the installation.



4. Select the proper destination directories.

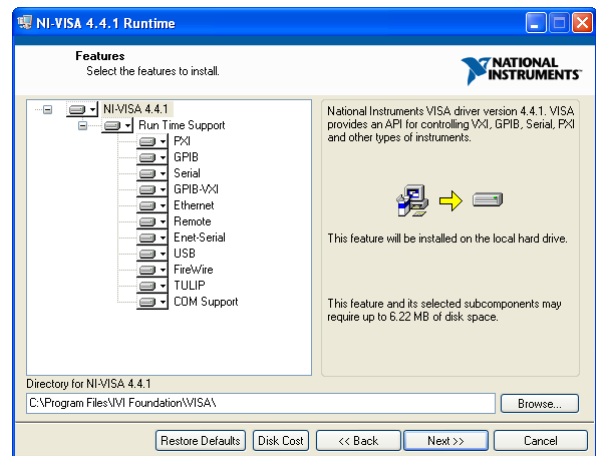
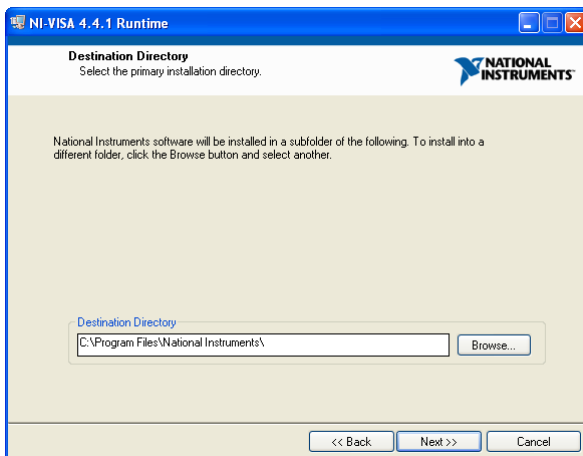

5. Accept the License Agreements.

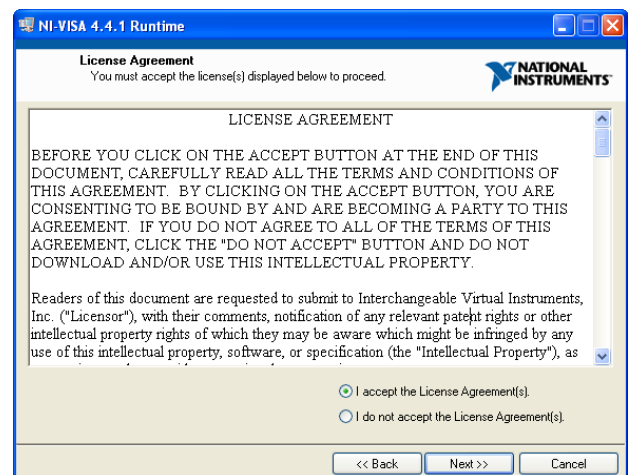
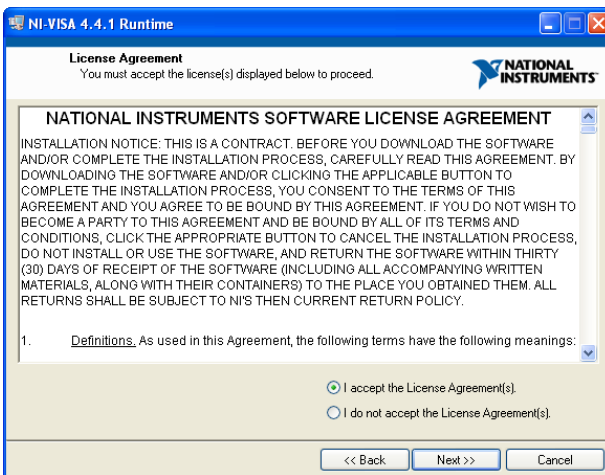

6. The following screen appears. Click **Next**.

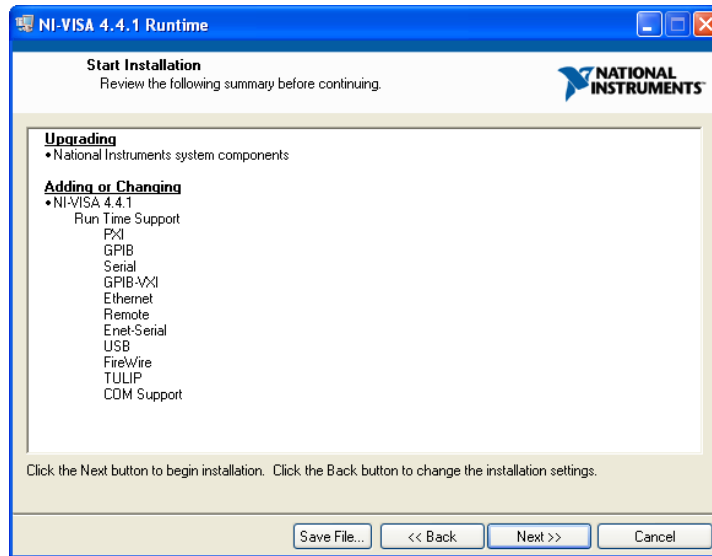

7. Click **Finish**.

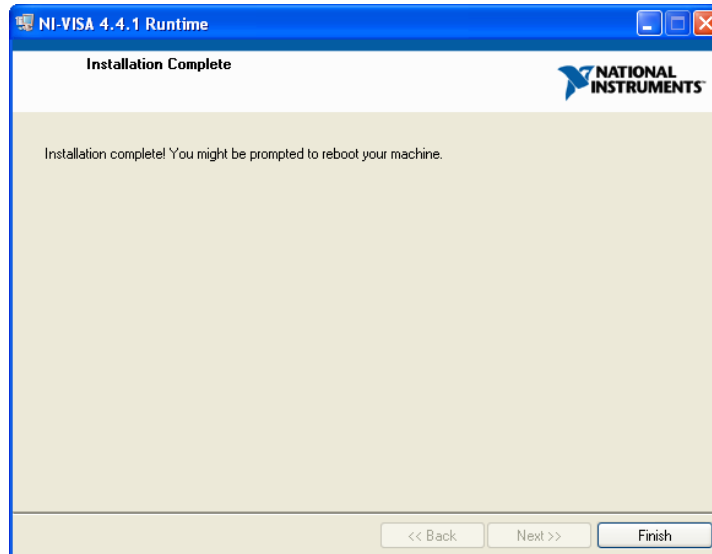

8. Copy the OMU GUI V2p1.exe application file from the CD to your PC.

9. Restart your computer.

3 Operating the Dashboard GUI

Start the Dashboard Program using launching **Teridian OMU GUI V2p1.exe**.

3.1 Port Selection

The COM port must be selected before data can be received from the AC-PMON. Select the COM port assignment previously defined on the Device Manager screen in [Section 2.2](#).

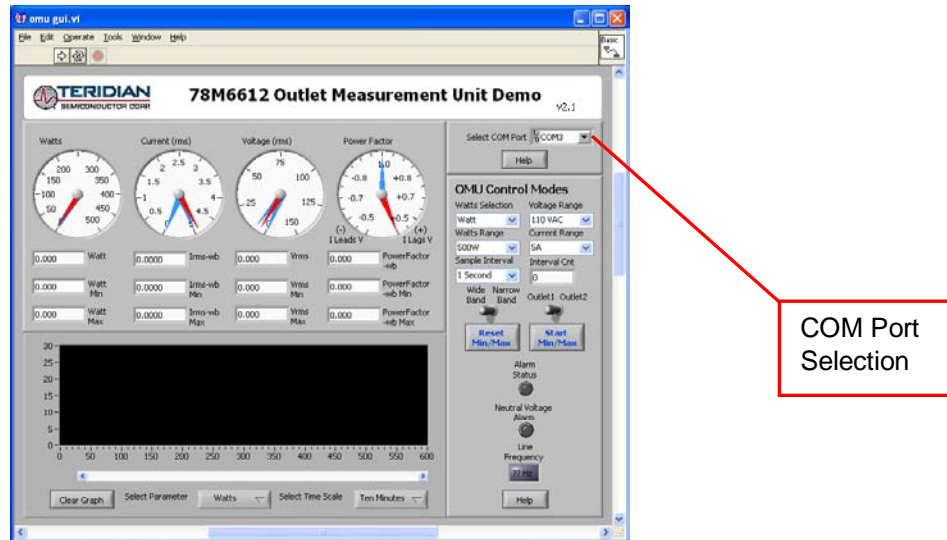

The **Run** and **Stop** buttons are located above the Teridian logo.

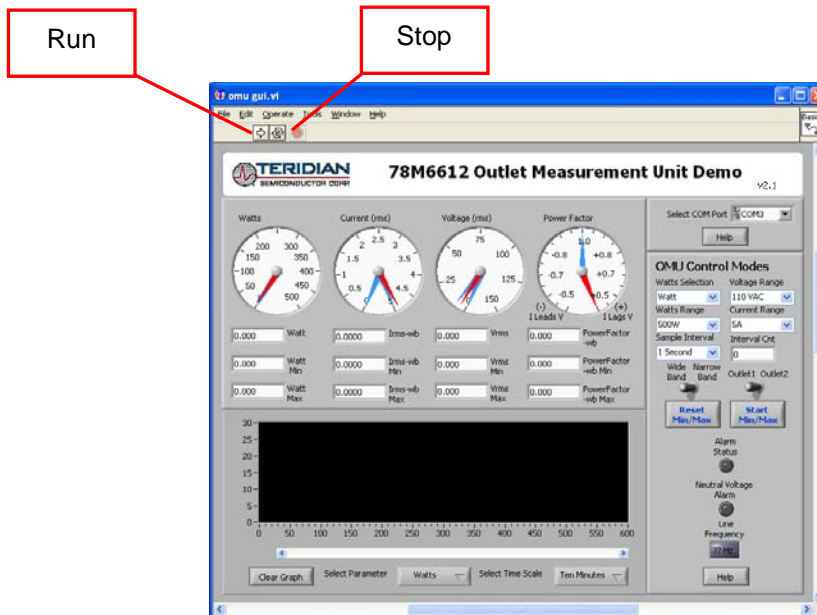

If the AC-PMON is disconnected from the USB cable, close and restart the GUI to re-establish the USB COM port connection.

3.2 Creating a Measurement Data Log File

Upon clicking the **Run** button, a File Write dialog box appears. The GUI stores retrieved measurement data to a file for post processing. Enter the desired subdirectory and file name. Click **OK** to launch the main GUI display.

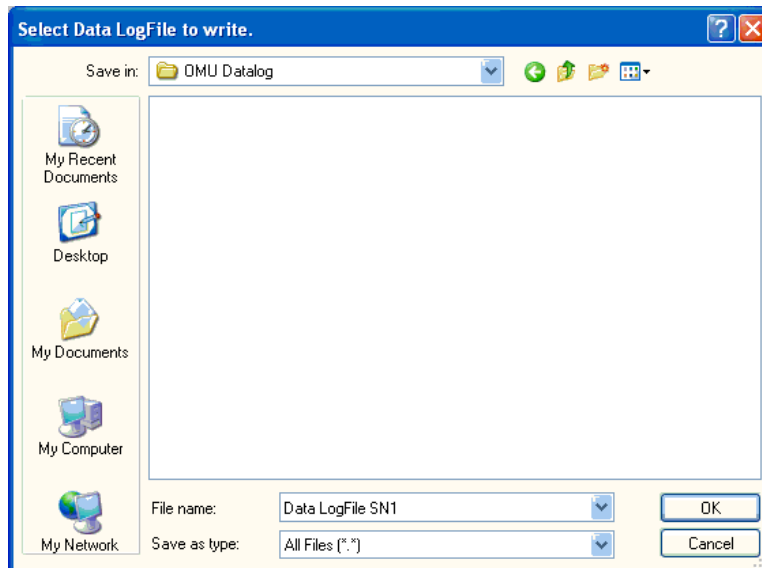

The measurement data is stored as text characters delimited by commas. Click the **Stop** button to close the text file and end the data logging function. New data log files are created wherever the **Run** button is clicked. The data log capture automatically stops after 12 hours. 12 hours of data results in a 12 MB file. To import the data log file into Excel, see [Section 3.19](#).

3.3 Selecting the Power Display Parameter

Using the **Watts Selection** menu under **OMU Control Modes**, select **Watt**, **VA** or **VAR** as the power display parameter.

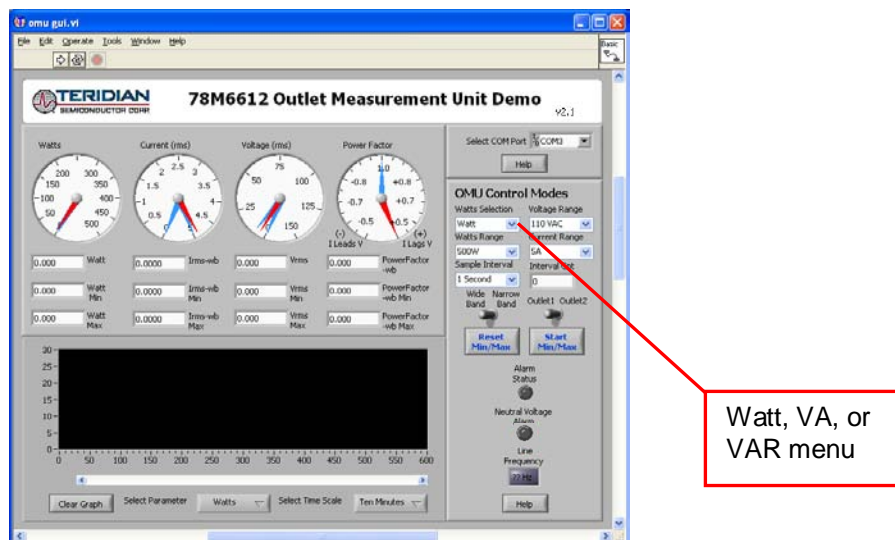

Real power is the time average of the instantaneous product of voltage and current (**Watt**). Apparent power is the product of rms (root mean square) volts and rms amps (**VA**, volt-amps). Reactive power is the time average of the instantaneous product of the voltage and current, with current phase shifted 90 degrees (**VAR**, voltamps reactive).

3.4 Selecting the Display Scales

The range of values displayed in the **Watts** dial, the **Current (rms)** dial, and the **Voltage (rms)** dial can be changed. Use the **Voltage Range**, **Watts Range** and **Current Range** menus under **OMU Control Modes** to select the display scales for Watts, Current, and Voltage.

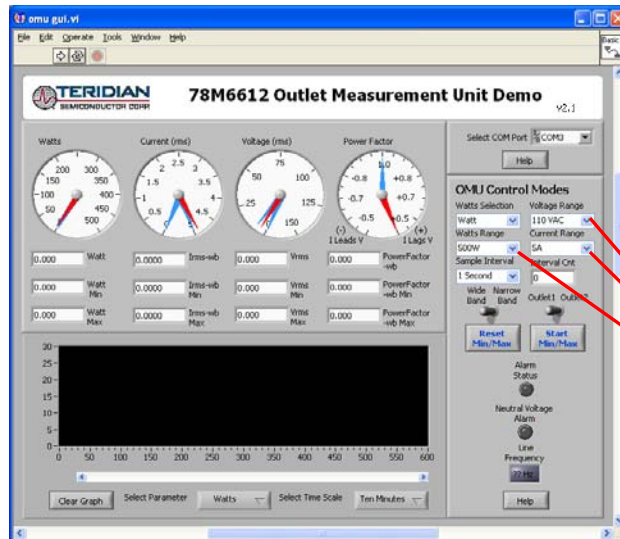

Scale for Voltage, Watts and Current

3.5 Resetting the Min and Max Indicators to Their Current Values

The **Reset Min/Max** button sets the Minimum and Maximum display values to the current conditions. Press the **Reset Min/Max** button to store the measured values in the first row of the display into the second row (the Min values) and the third row (the Max values).

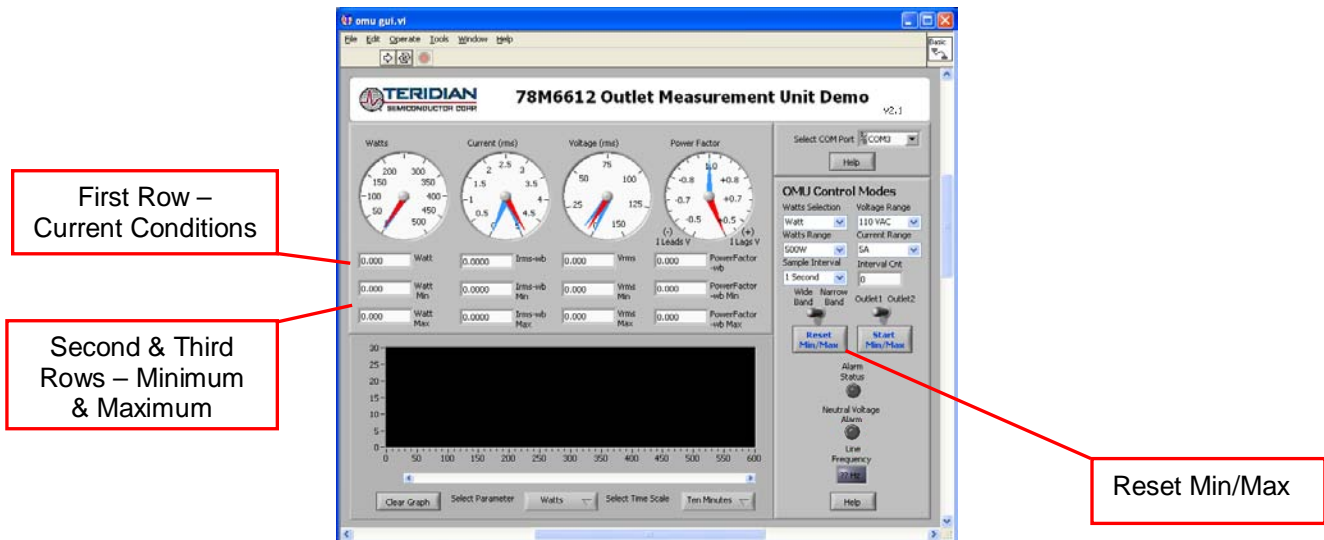

3.6 Begin Tracking Minimum and Maximum Conditions

To begin tracking minimum and maximum conditions as they occur, click the **Start Min/Max** button. Minimum values will display in the second row and maximum values will display in the third row.

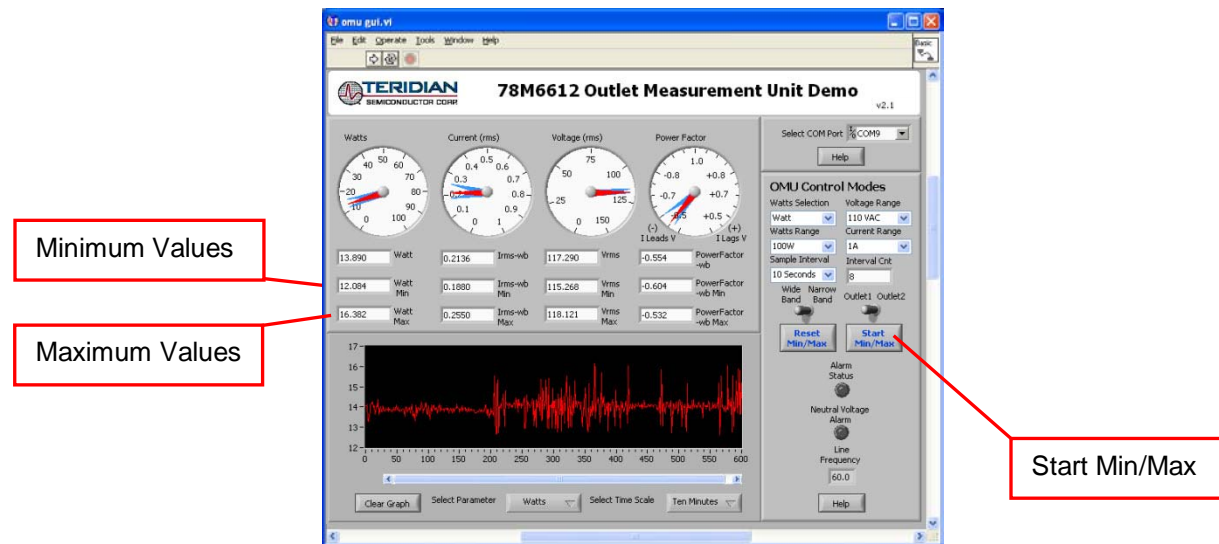

3.7 Selecting Outlet1

The GUI has provisions to display two loads: **Outlet1** and **Outlet2**. However, the AC-PMON contains only one load socket. Select **Outlet1** for use with the AC-PMON. All **Outlet2** power and current measurement displays show "0.00" due to the missing load circuit. Similarly, all Totals measurement displays mirror the Outlet1 results. The GUI also provides configuration for two load relays. The AC-PMON does not contain relays.

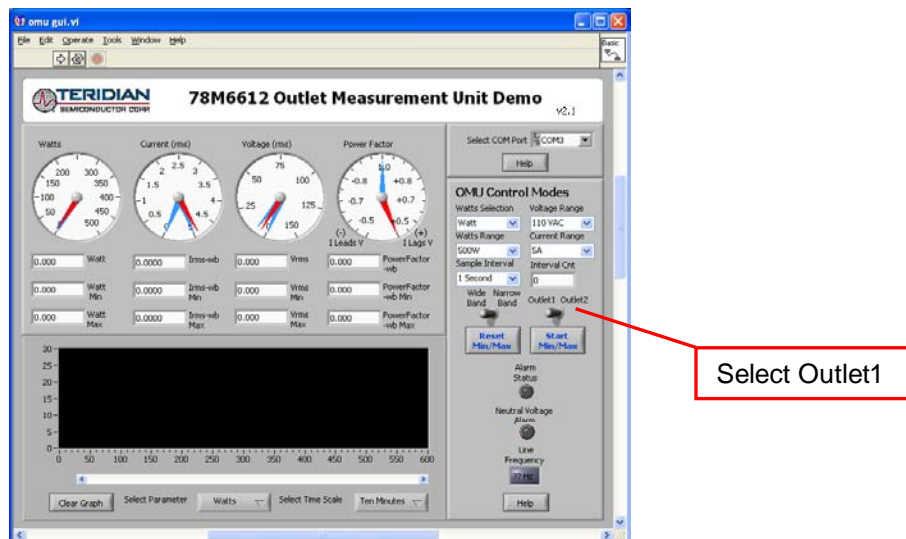

3.8 Selecting Wide Band or Narrow Band Measurement

The GUI provides for two measurement algorithm options. The **Wide Band** measurement method is optimal for measuring power from equipment with switching power supplies. The **Narrow Band** method works well with conventional loads. All measurement displays, dials and graph are updated with the appropriate data based on the **Wide Band / Narrow Band** selection.

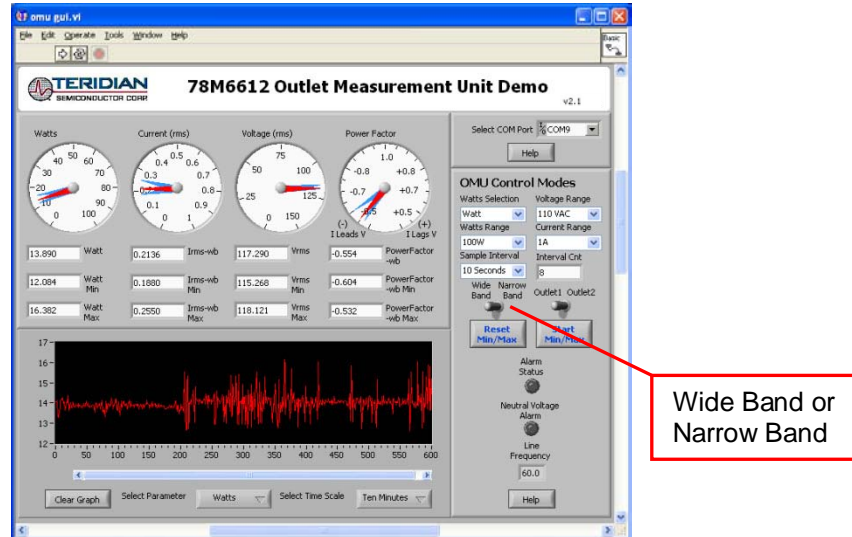

3.9 Selecting the Sample Interval

Sample Interval provides a menu of sample sizes for display averaging. The 1 Second setting updates the display with every sample once a second. The 5 Seconds setting averages 5 samples and updates the display every 5 seconds, etc. **Interval Cnt** provides an index for the next display update. For example, if **Sample Interval** is set to 5 Seconds, **Interval Cnt** will count from 1 to 5.

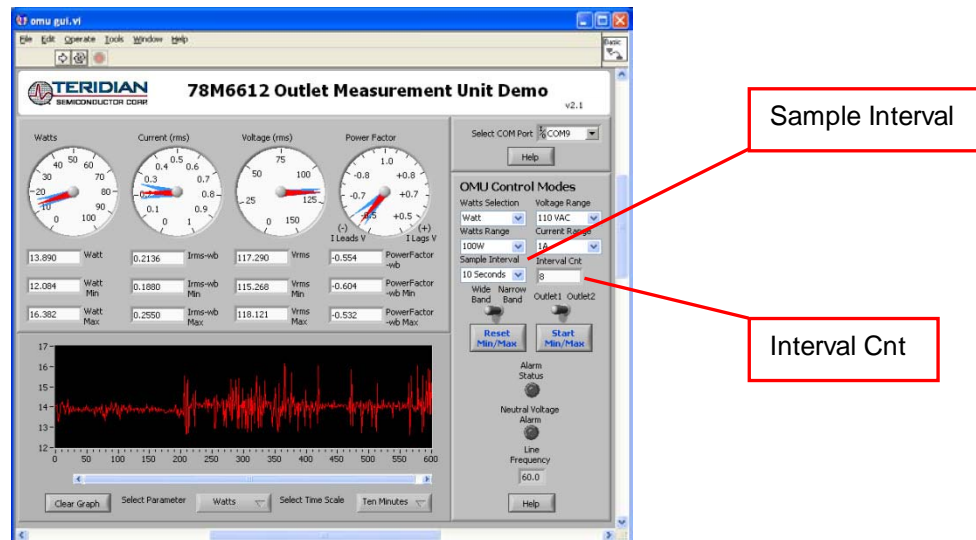

3.10 Alarm Status

The **Alarm Status** indicator turns red if any Alarm Status Threshold is exceeded. See [Section 3.16](#) for more information.

3.11 Neutral Voltage Alarm

The Neutral Voltage Alarm turns red when the Line and Neutral wires are reversed and Earth GND is connected. Earth GND must be connected for this function to operate properly.

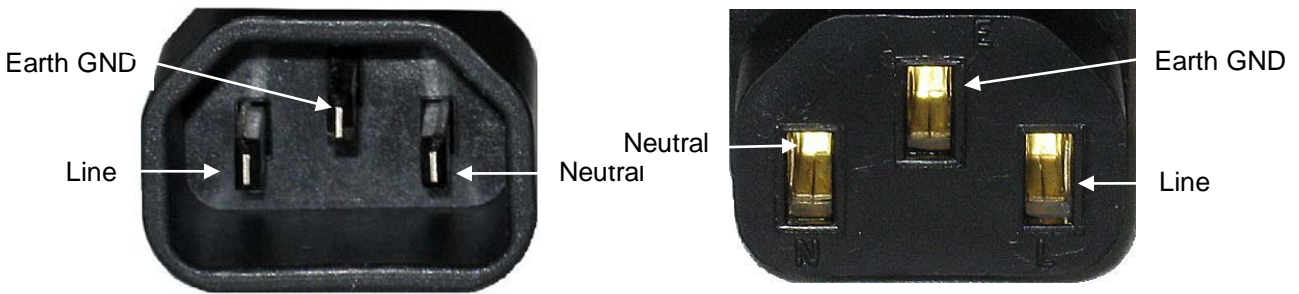
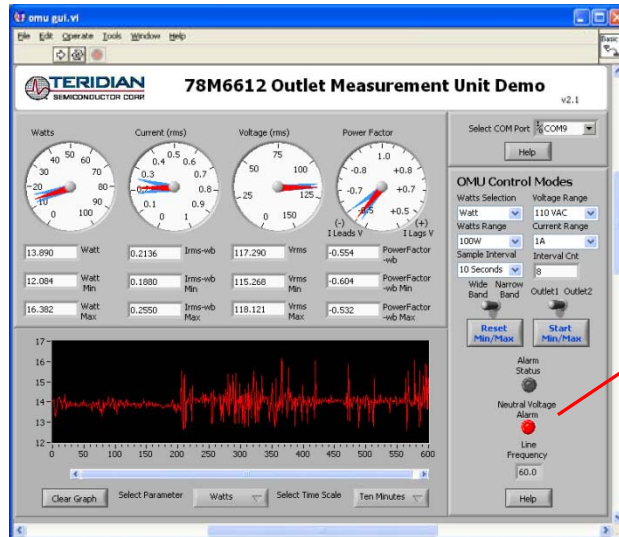

3.12 Line Frequency

The **Line Frequency** indicator displays the existing line frequency. Frequency is displayed with 0.1 Hz resolution. “???” is displayed when no voltage is present.

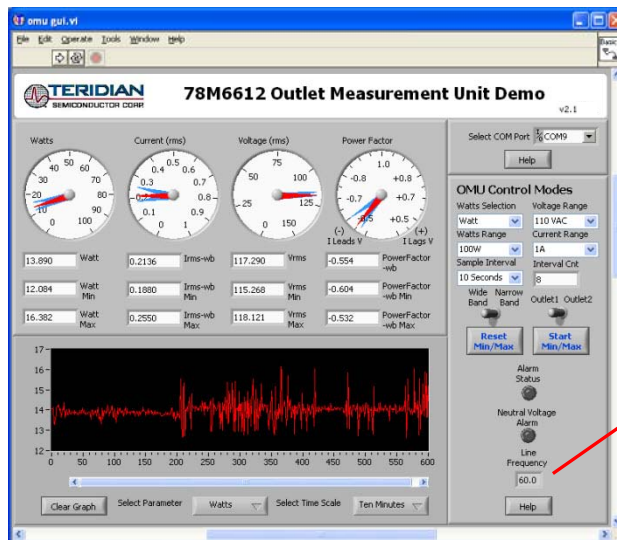

3.13 Accumulated Energy Usage and Expense Tracking

If a **Cost per KWh** value is entered, the AC-PMON will calculate and display the accumulated energy cost.

- Slide the vertical scroll bar down to display the **Present Cost/KWh**, which shows the currently stored value in the AC-PMON.
- Enter a new value, such as 10, in the box below and click the **Write KWh Cost** button to save this updated cost information. Do not hit the keyboard's Enter key after typing in the new numeric value.
- The **Total Energy** and **Total Cost** windows (under **Duplex Totals**) update automatically with the new information.
- The accumulated **Total Energy** and **Total Cost** windows are reset by clicking the **Reset Min/Max** button.

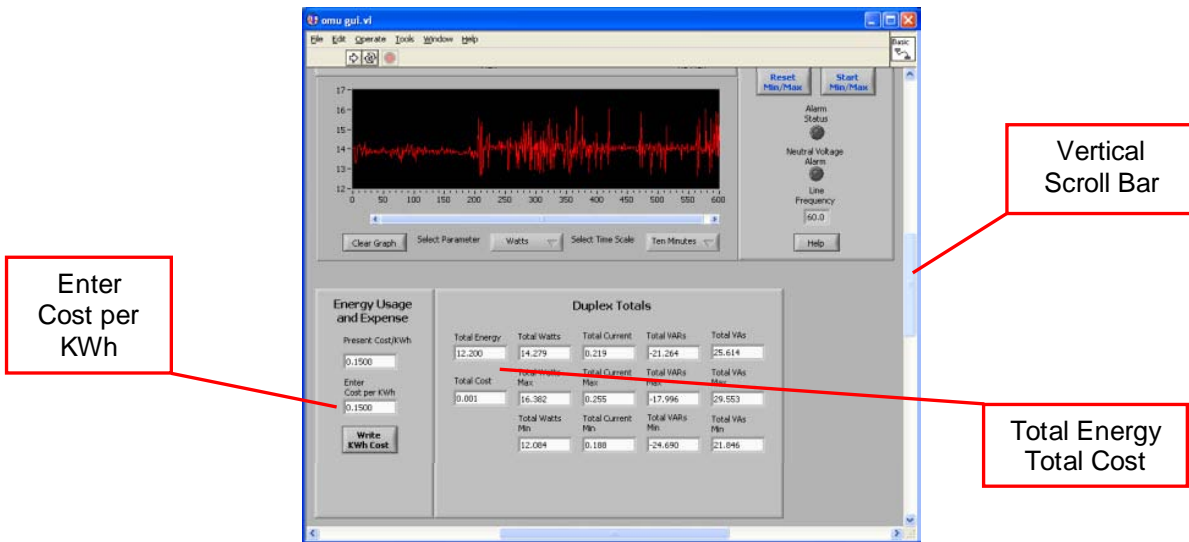

3.14 Displaying Narrowband and Wideband Values Simultaneously

Slide the horizontal scroll bar to the right to view both sets of data.

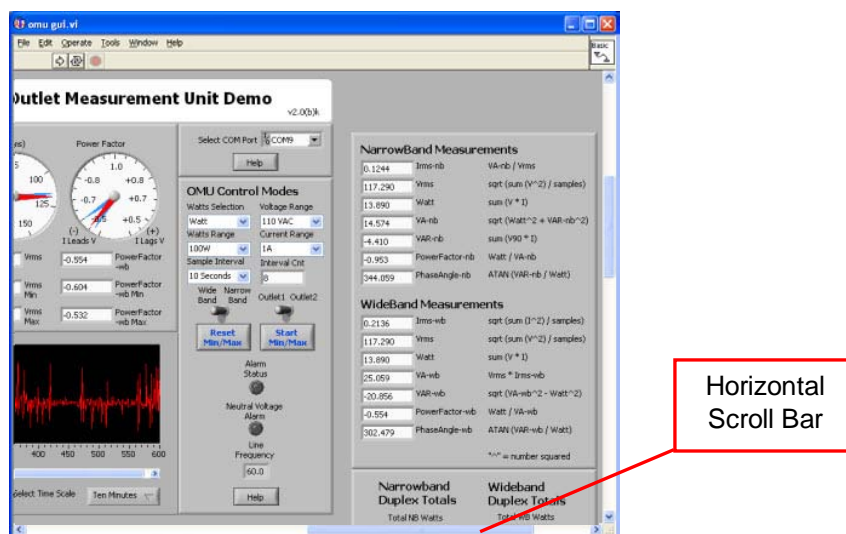

3.15 Using the Parameter Graph

Use the Parameter Graph to display sample size averages for a specified parameter and time scale.

- Select the parameter to chart using the **Select Parameter** menu.
- Select the time scale using the **Select Time Scale** menu.

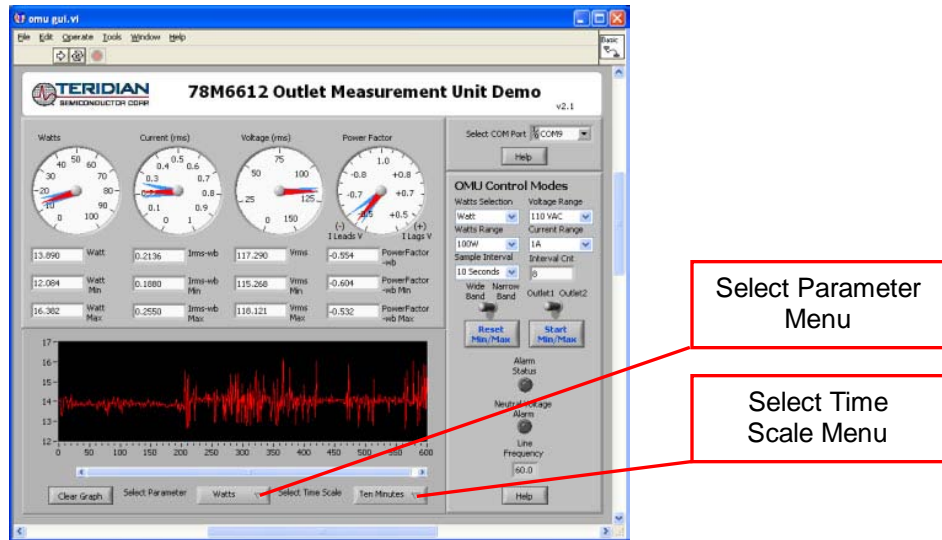

3.16 Setting Alarm Status Thresholds

The AC-PMON can trip an alarm whenever a specified minimum or maximum temperature, frequency, voltage, maximum current narrowband, maximum current wideband, power FTC narrowband and power FTC wideband. When the specified value is exceeded, the corresponding **Alarm Status Indicator** turns red. Also, the **Alarm Status** on the Dashboard turns red.

- To the left of the main control panel are the **Alarm Status Indicators**. Use the horizontal scroll bar to bring the indicators into view.

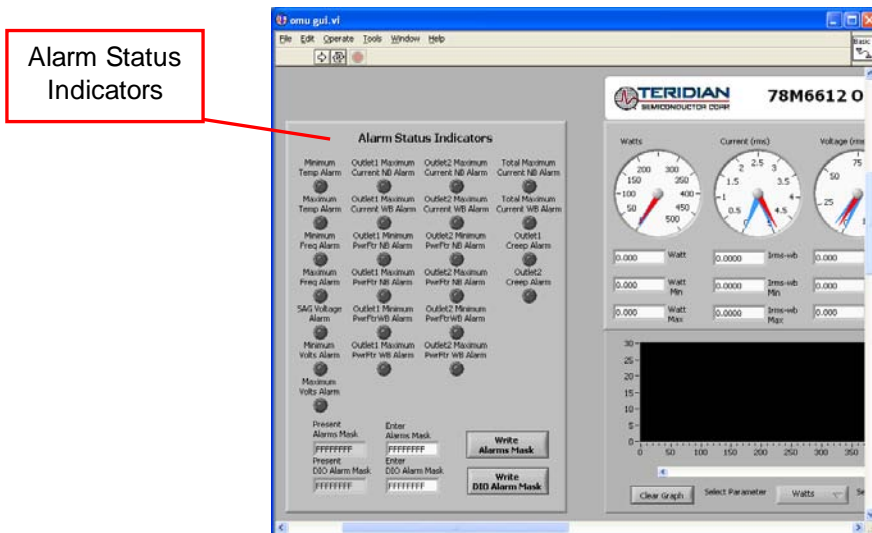

- Below the **Alarm Status Indicators** are the current AC-PMON values and data entry boxes to change the AC-PMON event counter threshold values.

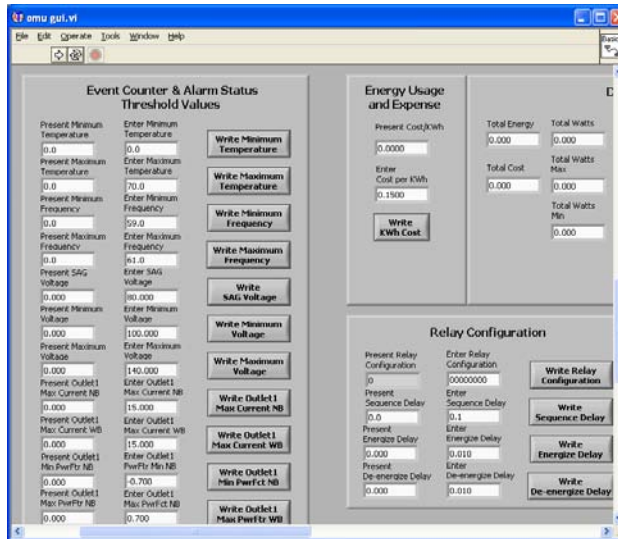

Enter Value(s)

- Enter a new value and click on the respective **Write** button to save the new value to the AC-PMON.
- Do not press the keyboard's **Enter** key after typing in a new numeric value.

3.17 Relay Configuration Controls

The AC-PMON does not contain relays. **Do not use the Relay Configuration controls with the AC-PMON.**

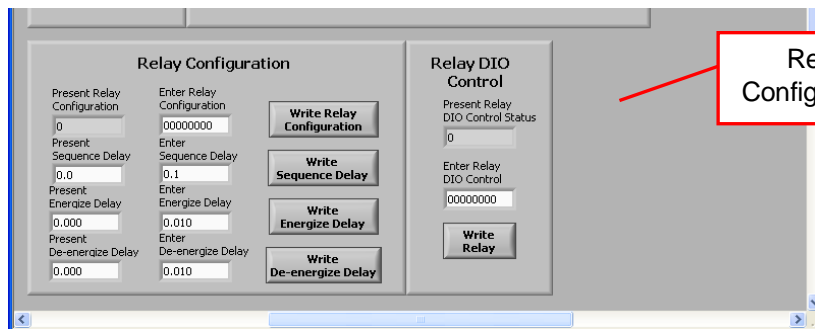

Relay Configuration

3.18 Log File Import to Excel®

The AC-PMON measurement data can be graphed and post processed by importing its text data into various analysis programs. The column data is separated by commas. The first dozen lines contain AC-PMON informational data. The measurement data follows with each 1-second sample stored as a separate line item.

To import the log data into Excel, begin by clicking on the Excel **File/Open** option from the main menu.

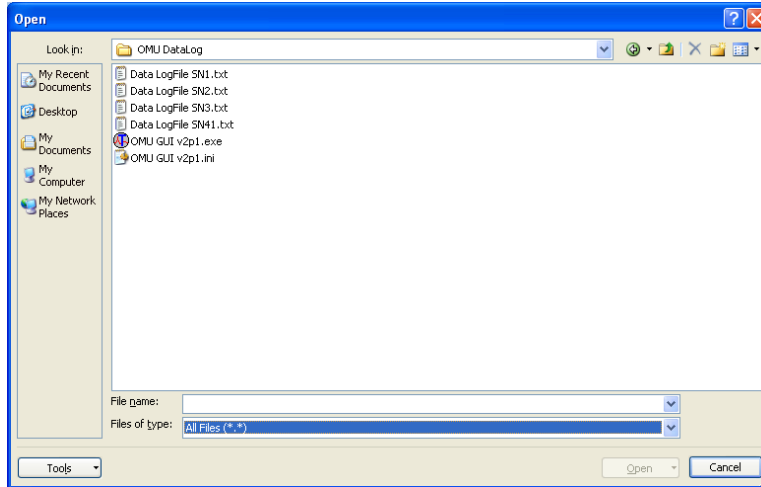

Change the **Files of type** to all **Files (*.*)**. Then find your sub-directory and select your data log file.

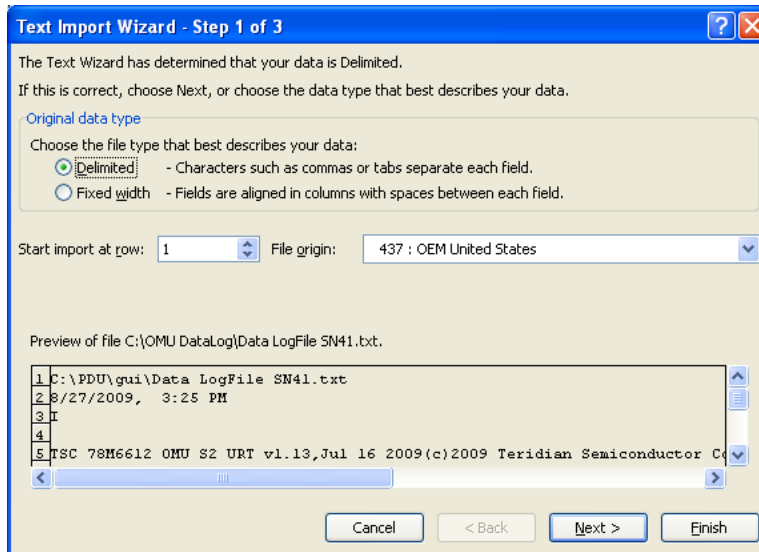

No changes required on the next dialog box, click **Next**.

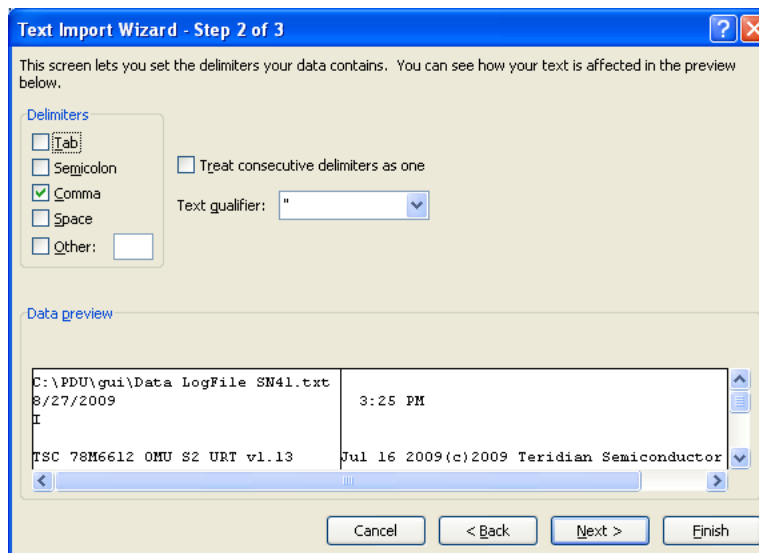

Uncheck **Tab** and then check **Comma**. Click **Next** to proceed.

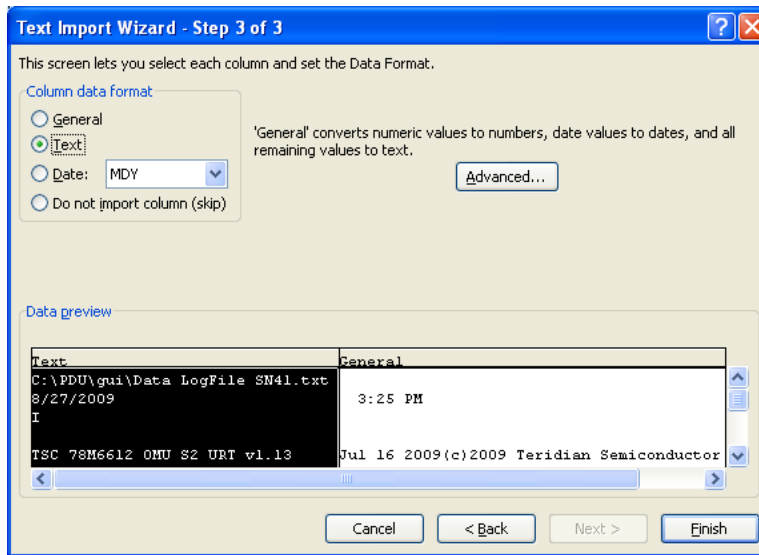

Select **Text** for Column data format. Click **Finish** to complete importing log file data.

The log file text data can now be parsed using standard Excel formulas.

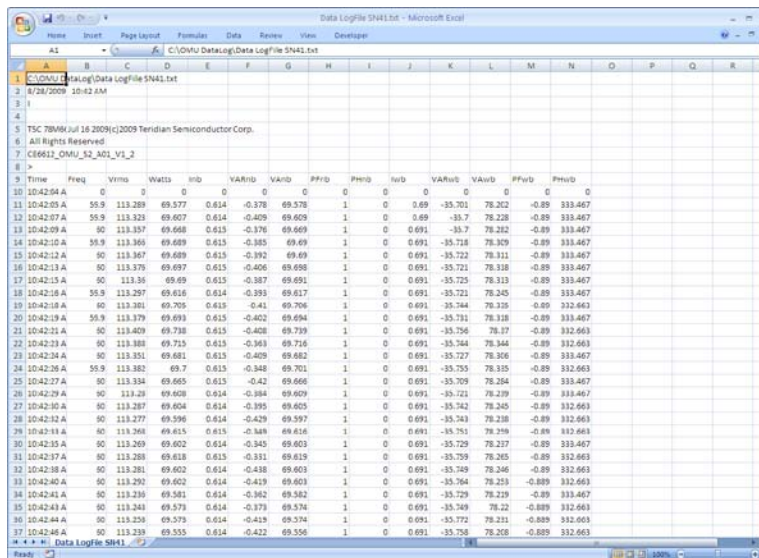

4 Schematics, Bill of Materials and PCB Layouts

This section includes the schematics, bill of materials and PCB layouts for the 78M6612 AC-PMON Evaluation Board and the schematics and bill of materials for the USB Daughter Board.

4.1 78M6612 AC-PMON Evaluation Board Schematics

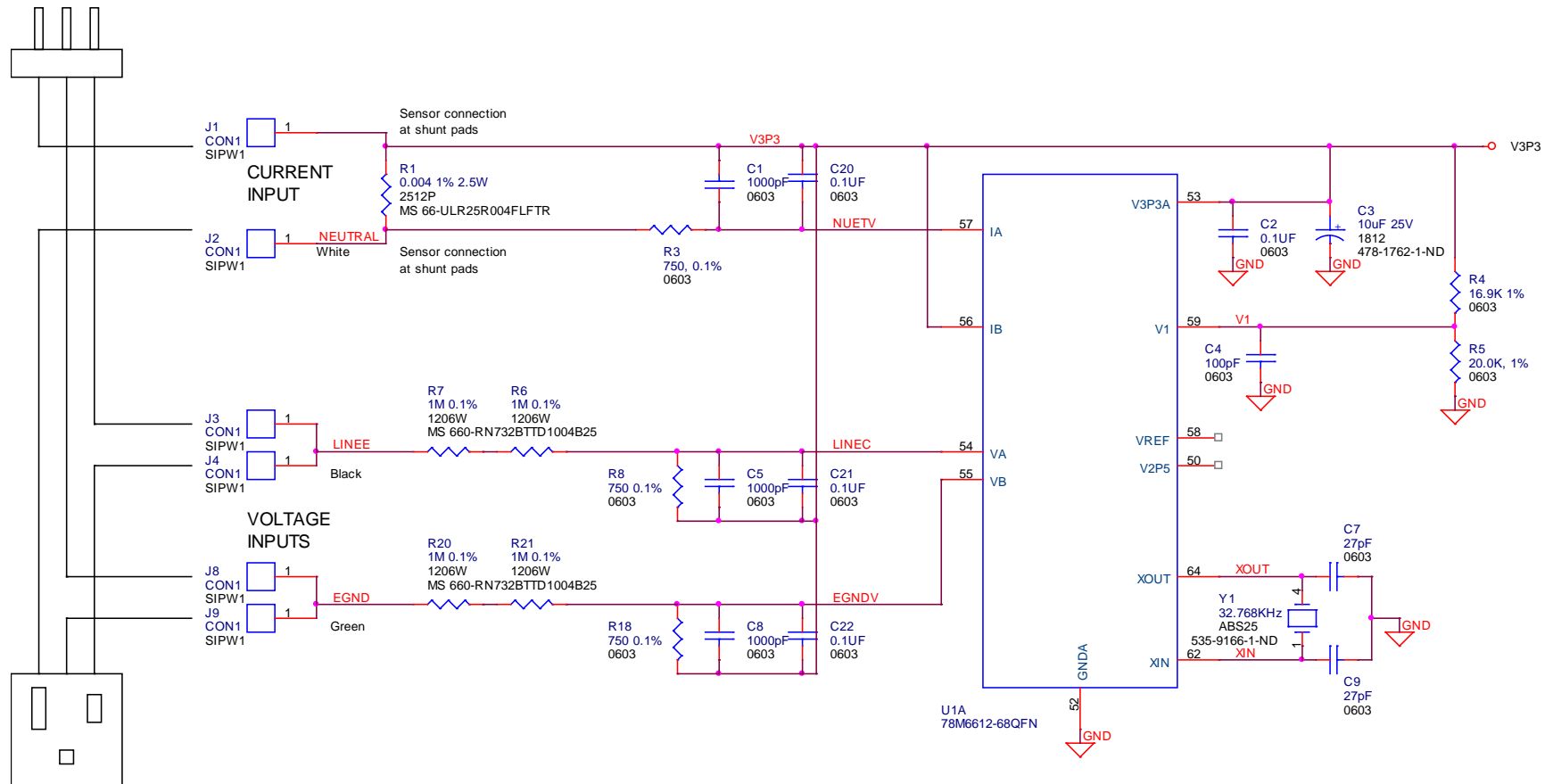

Figure 3: 78M6612 AC-PMON Evaluation Board Electrical Schematic (1 of 2)

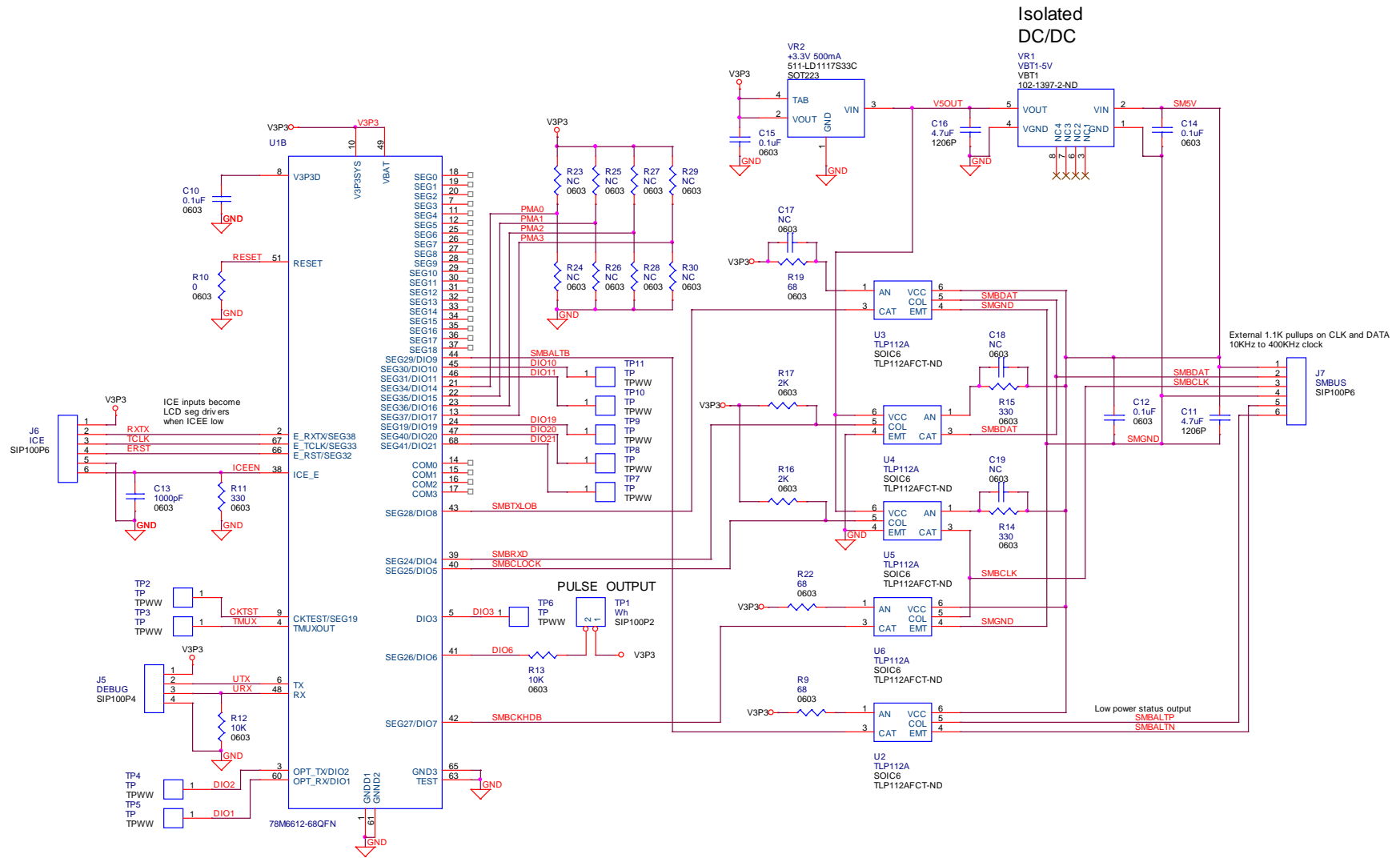

Figure 4: 78M6612 AC-PMON Evaluation Board Electrical Schematic (2 of 2)

4.2 78M6612 AC-PMON Evaluation Board Bill of Materials

Table 2: 78M6612 Evaluation Board Bill of Materials

Item	Q	Reference	Part	PCB Footprint	Digi-Key/Mouser Part Number	Part Number	RoHS	Manufacturer
1	4	C1,C5,C8,C13	1000pF	RC0603	445-1298-1-ND	C1608X7R2A102K	X	TDK
2	8	C2,C10,C12,C14,C15,C20,C21,C22	0.1uF	RC0603	445-1314-1-ND	C1608X7R1H104K	X	TDK
3	3	C3	10uF, 25V	RC1812	478-1762-1-ND	TPSC106K025R0500	X	AVX
4	1	C4	100pF	RC0603	445-1281-1-ND	C1608C0G1H101J	X	TDK
5	2	C7,C9	27pF	RC0603	445-1274-1-ND	C1608C0G1H270J	X	TDK
6	2	C11,C16	4.7uF	RC1206	445-1606-1-ND	C3216X7R1E475K	X	TDK
7	1	J5	HEADER 4	4X1PIN	S1011E-36-ND	PBC36SAAN	X	SULLINS
8	1	J6	HEADER 6	6X1PIN	S1011E-36-ND	PBC36SAAN	X	SULLINS
9	1	J7	HEADER 6	6X1PIN	S1011E-36-ND	PBC36SAAN	X	SULLINS
10	1	R1	0.004, 1%, 2.5W	2512	66-ULR25R004FLFTR	ULR25R004FLFTR	X	IRC
11	3	R3,R8,R16	750, 0.1%	RC0603	RG16P750BCT-ND	RG1608P-751-B-T5	X	Susumu
12	1	R4	16.9K, 1%	RC0603	P16.9KHCT-ND	ERJ-3EKF1692V	X	Panasonic
13	2	R5	20.0K, 1%	RC0603	P20.0KHCT-ND	ERJ-3EKF2002V	X	Panasonic
14	4	R6,R7,R20,R21	1M, 0.1%	RC1206	660-RN732BTDD1004B25	RN732BTDD1004B25	X	KOA SPEER
15	3	R9,R19,R22	68	RC0603	P68GCT-ND	ERJ-3GEYJ680V	X	Panasonic
16	1	R10	0	RC1206	P0.0ECT-ND	ERJ-8GEY0R00V	X	Panasonic
17	3	R11,R14,R15	330	RC0603	P330GCT-ND	ERJ-3GEYJ331V	X	Panasonic
18	2	R12,R13	10K	RC0603	P10KGCT-ND	ERJ-3GEYJ103V	X	Panasonic
19	2	R16,R17	2K	RC0603	P2.0KGTR-ND	ERJ-3GEYJ202V	X	Panasonic
20	1	TP1	HEADER 2	2X1PIN	S1011E-36-ND	PBC36SAAN	X	SULLINS
21	1	U1	78M6612-IM	68QFN	-	78M6612-IM	X	Teridian
22	5	U2,U3,U4,U5,U6	OPTOCOUPLER	5-MFSOP	TLP112AFCT-ND	TLP112A(TPR,F)	X	Toshiba
23	1	VR1	VBT1-5V	VBT1	102-1397-1-ND	VBT1-S5-S5-SMT	X	CUI
24	1	VR2	3.3V, 500mA	SOT223	511-LD1117S33C	LD1117S33CTR	X	STMicroelectronics
25	1	Y1	32.768 KHZ SMD 12.5Pf	ABS25	535-9166-1-ND	ABS25-32.768KHZ-T	X	Abracon

4.3 78M6612 AC-PMON Evaluation Board PCB Layouts

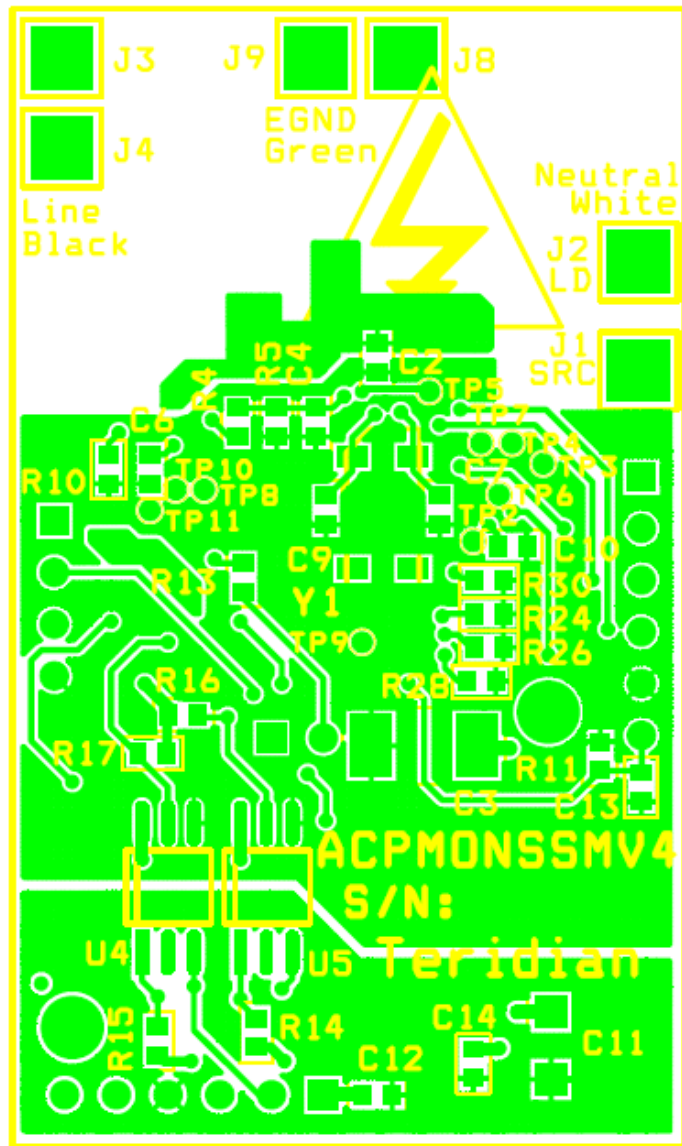

Figure 5: 78M6612 Evaluation Board PCB Top View

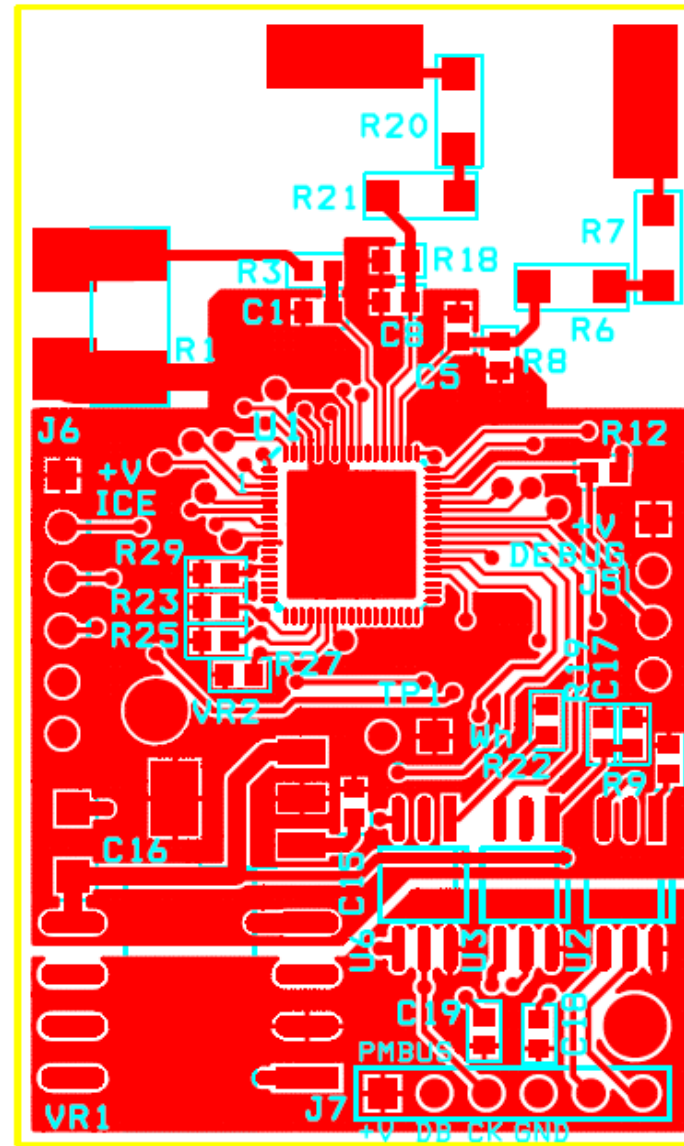

Figure 6: 78M6612 Evaluation Board PCB Top Copper

4.4 USB Daughter Board Schematics

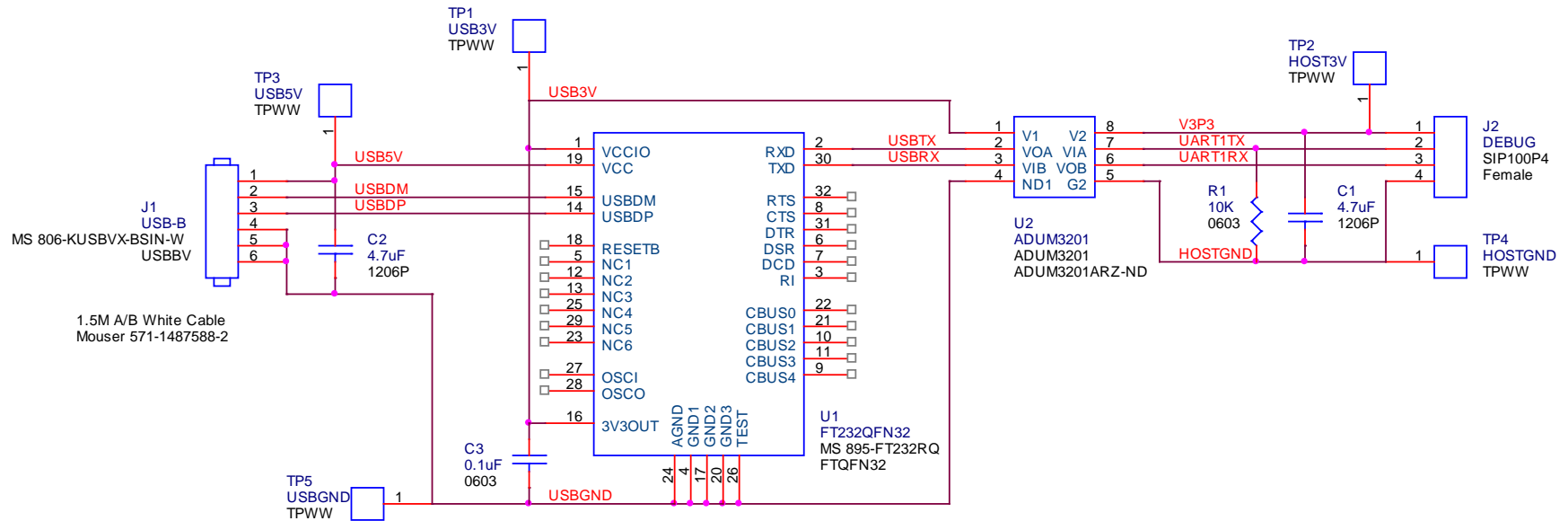

Figure 7: USB Daughter Board Electrical Schematic

4.5 USB Daughter Board Bill of Materials

Table 3: USB Daughter Board Bill of Materials

Item	Q	Reference	Part	PCB Footprint	Digi-Key/Mouser Part Number	Part Number	RoHS	Manufacturer
1	2	C1,C2	4.7uF	RC1206	445-1606-1-ND	C3216X7R1E475K	X	TDK
2	1	C3	0.1uF	RC0603	445-1314-1-ND	C1608X7R1H104K	X	TDK
3	1	J1	US Connector	USBV	806-KUSBVX-BS1N-W	KUSBVX-BS1N-W	X	Kycon
4	1	J2	HEADER 4	4X1PIN	ED6350-ND	801-43-050-10-001000	X	Mill-Max
5	1	R1	10K	RC0603	P10KGCT-ND	ERJ-3GEYJ103V	X	Panasonic
6	1	U1	USB TO SERAIL IC	32QFN	895-FT232RQ	FT232RQ	X	FTDI
7	1	U2	OPTOISOLATER	8SOIC	ADUM3201ARZ-ND	ADUM3201ARZ	X	ADI

5 Ordering Information

Part Description	Order Number
78M6612 AC-PMON Evaluation Board	78M6612-EVM-1

6 Included Documentation

The following 78M6612 documents are included on the CD:

78M6612 Data Sheet

6612_OMU_S2_URT_V1_13 Firmware Description Document

7 Contact Information

For more information about Teridian Semiconductor products or to check the availability of the 78M6612, contact us at: <http://www.teridian.com/contact-us/>

6440 Oak Canyon Road
Suite 100
Irvine, CA 92618-5201

Telephone: (714) 508-8800
FAX: (714) 508-8878

Revision History

Revision	Date	Description
1.0	11/6/2009	First publication.
1.1	2/1/2010	Updated the schematics in Figure 3 and Figure 4. Updated the bill of materials in Table 2 and Table 3.